

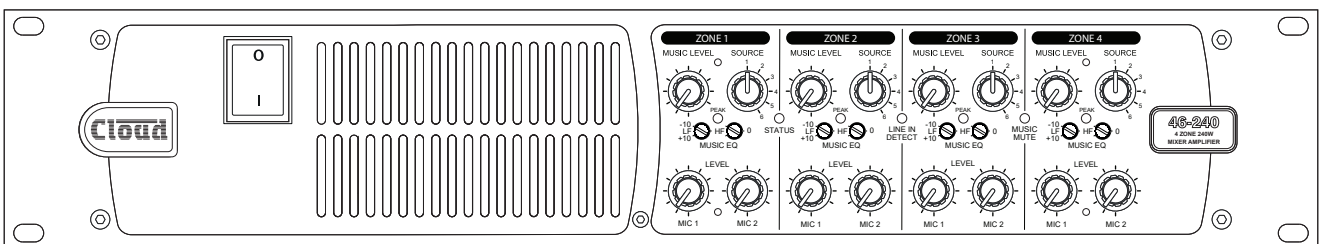

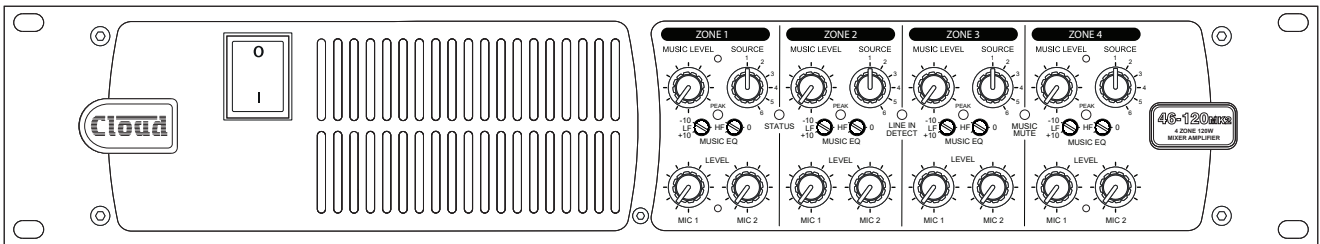

46 SERIES FOUR ZONE MIXER-AMPLIFIERS



Installation and User Guide

WARNING:

To reduce the risk of fire or electric shock, do not expose this appliance to rain or moisture.

 <p>CAUTION RISK OF ELECTRIC SHOCK DO NOT OPEN</p>	<p>WARNING: SHOCK HAZARD – DO NOT OPEN AVIS: RISQUE DE CHOC ELECTRIQUE – NE PAS OUVRIR</p>
	<p>The lightning flash with the arrowhead symbol within an equilateral triangle is intended to alert you to the presence of uninsulated dangerous voltages within the product's enclosure that may be of sufficient magnitude to constitute a risk of electric shock..</p>
	<p>The exclamation point within an equilateral triangle is intended to alert the user to the presence of important operating and maintenance (servicing) instructions in the literature accompanying the appliance.</p>

IMPORTANT SAFETY INSTRUCTIONS

1. Read these Instructions.
2. Keep these Instructions.
3. Heed all Warnings.
4. Follow all Instructions.
5. Do not use this apparatus near water.
6. Clean only with a dry cloth.
7. Do not block any ventilation openings. Install in accordance with the manufacturers' instructions.
8. Do not install near any heat sources such as radiators, heat registers, stoves or other apparatus (including amplifiers) that produce heat.
9. Do not defeat the safety purpose of the polarized or grounding - type plug. A polarized plug has two blades with one wider than the other. A grounding type plug has two blades and a third grounding prong. The wide blade or the third prong are provided for your safety. When the provided plug does not fit into your outlet, consult an electrician for replacement of the obsolete outlet.
10. Protect the power cord from being walked on or pinched particularly at plugs, convenience receptacles, and the point where they exit from the apparatus.
11. Only use attachments/accessories specified by the manufacturer.
12.  Use only with the cart, stand, tripod, bracket or table specified by the manufacturer or sold with the apparatus, when a cart is used, use caution when moving the cart/apparatus combination to avoid injury from tip-over.
13. Unplug this apparatus during lightning storms or when unused for long periods of time.
14. Refer all servicing to qualified service personnel. Servicing is required when the apparatus has been damaged in any way, such as power-supply cord or plug is damaged, liquid has been spilled or objects have fallen into the apparatus, the apparatus has been exposed to rain or moisture, does not operate normally, or has been dropped.



Do not expose the apparatus to dripping or splashing, and ensure that no objects filled with water, such as vases, are placed on the apparatus.

L'appareil ne doit être exposé aux écoulements ou aux éclaboussures et aucun objet ne contenant de liquide, tel qu'un vase, ne doit être placé sur l'appareil.



The mains plug is used as the disconnect device and it should remain readily accessible during intended use. In order to isolate the apparatus from the mains, the mains plug should be completely removed from the mains outlet socket.

Le prise du secteur ne doit pas être obstruée ou doit être facilement accessible pendant son utilisation. Pour être complètement déconnecté de l'alimentation d'entrée, la prise doit être débranchée du secteur.



This apparatus is of Class 1 construction and must only be connected to a mains outlet socket with a protective earthing connection.



Terminals marked with the ⚡ symbol may use Class 2 Wiring, but voltages at these terminals may be of sufficient magnitude to constitute a risk of electric shock. The external wiring connected to these terminals requires installation by an instructed person or the use of pre-made leads or cords.

Contents

SAFETY INFORMATION	6
Safety Notes regarding Installation	6
Conformities.....	6
RoHS and WEEE declaration	6
Safety Considerations and Information.....	6
Caution – High Voltage	6
Caution – Mains Fuse	6
Caution – Servicing.....	6
OVERVIEW	7
Introduction.....	7
Applicable Models.....	7
46 Series main features.....	7
What’s in the box.....	8
Schematic Diagram	9
Front panel description.....	10
Rear panel description.....	11
INSTALLATION	13
Hardware considerations.....	13
Ventilation	13
Power Supply.....	13
Fuses and ratings	13
Connections and Controls	14
Music Inputs	14
Sensitivity & Gain Control.....	14
Music Source Select	14
Music Level Controls	14
Remote Control of Music Source and Level	14
Music Equalisation	15
Music Priority	15
Microphone Inputs.....	15
Mic Input – connections	15
Gain Control	15
Microphone level controls	15
Microphone Equalisation	15
Paging control and mic priority.....	16
Microphone Access Input.....	16
Connecting a PM4/4SA paging mic via the Cloud Digital Paging Interface.....	16
Connecting a paging mic via the analogue interface.....	17
Outputs	18
Speaker Outputs	18
Connecting to Lo-Z loudspeakers.....	18
Connecting to 70/100 V-line systems.....	18
Power Sharing (Model 46-120MK2 only)	19
Parallel power stage operation.....	19
Auxiliary Outputs.....	20
Utility Output.....	20

Facility Ports	21
Remote control functions via the Facility Ports.....	21
Connecting an active remote module.....	22
Music Mute (Fire Alarm Interface)	23
Auto Power Down	23
Options and Additional Information	24
Control of music source and level via external DC	24
46 SERIES SERIAL CONTROL.....	25
Abridged command set.....	25
Examples	26
APPENDIX.....	27
PCB jumper locations.....	27
Table of internal jumpers and default settings.....	28
Troubleshooting	30
EMC Considerations	30
Earthing	30
TECHNICAL SPECIFICATIONS	31

SAFETY INFORMATION

Safety Notes regarding Installation

- Do not expose the unit to water or moisture.
- Do not expose the unit to naked flames.
- Do not block or restrict any air vent.
- Do not operate the unit in ambient temperatures above 35°C
- Do not touch any part or terminal carrying the hazardous live symbol ⚡ while power is supplied to the unit.
- Do not perform any internal adjustments unless you are qualified to do so and fully understand the hazards associated with mains-operated equipment.
- The unit has no user-serviceable parts. Refer servicing to qualified service personnel.
- If the moulded plug is cut off the mains lead for any reason, the discarded plug is a potential hazard and should be disposed of in a responsible manner.

Conformities

This product conforms to the following European EMC Standards:

BS EN 55035:2017 (Immunity)

BS EN 55032:2015 (Emissions)

BS EN 61000-3-2:2014 (Harmonics)



This product has been tested for use in commercial and light industrial environments. If the unit is used in controlled EMC environments, the urban outdoors, heavy industrial environments or close to railways, transmitters, overhead power lines, etc., the performance of the unit may be degraded.

The product conforms to the following European electrical safety standard:

BS EN 62368-1:2023

RoHS and WEEE declaration

Cloud Electronics Limited manages its business and collaborates with its suppliers to comply with the European Union restriction of the use of certain hazardous substances in electrical and electronic equipment, RoHS Directive (2002/95/EC), that came into force on 1st July 2006, and similar restrictions in other jurisdictions.



The "crossed out wheellie bin" symbol on the product and represented above is there to remind users of the obligation of selective collection of waste. This label is applied to various products to

indicate that the product is not to be thrown away as unsorted municipal waste. At the end of life, dispose of this product by returning it to the point of sale or to your local municipal collection point for recycling of electric and electronic devices.

Customer participation is important to minimize the potential effects on the environment and human health that can result from hazardous substances that may be contained in this product.

Please dispose of this product and its packaging in accordance with local and national disposal regulations, including those governing the recovery and recycling of waste electrical and electronic equipment. Contact your local waste administration, waste collection company or dealer

Safety Considerations and Information.

The unit must be earthed. Ensure that the mains power supply provides an effective earth connection using a three-wire termination.

Caution – High Voltage

Do not touch any part or terminal carrying the hazardous live symbol ⚡ while power is supplied to the unit. Terminals to which the hazardous live symbol refers require installation by a qualified person.

Caution – Mains Fuse

Cloud 46 Series mixer-amplifiers contain no user-replaceable fuses. Mains over-current protection is provided by the fuse in the IEC receptacle: only replace this fuse with one of an identical type and rating.

If the replacement fuse blows immediately, it indicates that the mixer amplifier has developed a fault, which should be referred to competent service personnel.

Caution – Servicing

The unit contains no user serviceable parts. Refer servicing to qualified service personnel. Do not perform servicing unless you are qualified to do so. Disconnect the power cable from the unit before removing the top panel and do not make any internal adjustments with the unit switched on. Only reassemble the unit using bolts/screws identical to the original parts.

OVERVIEW

Introduction

The Cloud 46 Series are four zone audio mixer-amplifiers, with applications in Licensed, Retail, Leisure and similar venues.

Two models are available to suit different output power requirements (4 x 120 or 4 x 240 watts). Otherwise the models have almost identical facilities.

The mixer-amplifiers have inputs for six stereo line signals and two microphone signals. Front panel controls are provided for music source selection, music level and microphone level in each of the four zones. Two multi-function Facility Ports allow the connection of remote active input modules.

An extensive selection of pre-set controls is located on the rear panel; primary unit configuration options are selectable using rear panel DIP switches. Certain installation options are set using internal PCB jumpers.

The units are compatible with standard Cloud RL-1 and RSL-6 remote control plates, and may also be remotely control using RS-232 and TCP/IP commands.

Applicable Models

This Installation and User Guide describes the installation and operation of the following models:

- Cloud 46-120MK2: 4 x 120 W mono mixer-amplifier for 4 or 8 ohm loudspeakers, or 70/100 V-line loudspeaker systems
- Cloud 46-240: 4 x 240 W mono mixer-amplifier for 4 or 8 ohm loudspeakers, or 70/100 V-line loudspeaker systems

All references to "46 Series" throughout this Installation and User Guide may be taken as being applicable to either model.

46 Series main features

- Provides amplification for four zones, with simple per-zone control of music, mic sources and paging in a single unit
- Available in two versions, with output power ratings of 120 or 240 W per zone
- Transformerless output stages: can be configured to drive either 70/100 V-line systems directly, or low impedance loudspeakers (4/8 ohms)
- Model 46-120MK2 permits power sharing in Hi-Z mode: maximum available power of 240 W may be shared as required between Zones 1 & 3 and Zones 2 & 4
- Front panel controls for music source, music level and mic levels in each zone
- Two unbalanced and four balanced stereo line inputs, with individual gain trim controls

- Two balanced mic inputs; 12 V phantom power available
- Fixed 100 Hz hi-pass mic channel filters
- Separate microphone limiter circuit to prevent power stage limiter from ducking music signal in the presence of high mic levels
- Separate HF/LF EQ adjustments for mic signals and music source
- Paging control of Mic 1 input via short-to-ground access connection for each zone
- CDPM Digital Paging port, for use with Cloud PM Series Paging Microphones
- Selectable VOX mic-over-music priority
- Selectable LINE 6 priority
- Music Mute control input (N/O and N/C) for interface to an emergency system
- Two assignable Facility Ports for connection of LM-2, L-1 or M-1 remote input modules via screened Cat 5 cable; LM-2 also allows remote control of music level and line input selection
- Facility Ports support BT-1 Bluetooth input modules
- Compatible with standard Cloud remote control plates: RL-1 Series (music level) and RSL-6 Series (music level and source selection)
- RS-232 serial and Ethernet TCP/IP control ports; protocol includes global and per-zone functions
- Alternative output routing available (Z1 preamp to Z1 and Z3, Z2 preamp to Z2 and Z4): allows higher power operation over fewer zones
- Power amplifier protection circuitry
- Power amplifier input limiters
- Switchable 65 Hz high-pass filter (per-zone): reduces transformer saturation in 70/100 V-line systems
- Balanced Utility output with separate rear panel controls for music/mic mix: music source can follow Zone 1 selection or be permanently LINE 1
- Two assignable auxiliary outputs from pre-amp (balanced, line level, pre/post music level routing options)
- Automatic power-down function (user-selectable)
- Thermostatically-controlled forced-air cooling
- 2U 19" rack mounting units

Available Options:

- LM-2 remote active mic/line input module with music source selection and volume controls
- BT-1 remote Bluetooth wireless audio input module
- L-1 remote active line input module
- M-1 remote active mic input module
- RL Series remote control plates for music volume
- RSL Series remote control plates for music source selection and level
- PM Series paging mics

What's in the box

Please check the shipping carton for damage before opening. If there is damage, please contact your Cloud agent and the shippers.

The packing carton should contain the following items:

- 46 Series mixer amplifier
- IEC mains lead (AC cord) with moulded plug appropriate to the territory
- Set of mating plug-in screw-terminal connectors
- Set of four plastic feet, with fixings
- This manual

Schematic Diagram

SINGLE ZONE SHOWN ONLY
RS232 & ETHERNET INTERFACES OMITTED FOR CLARITY

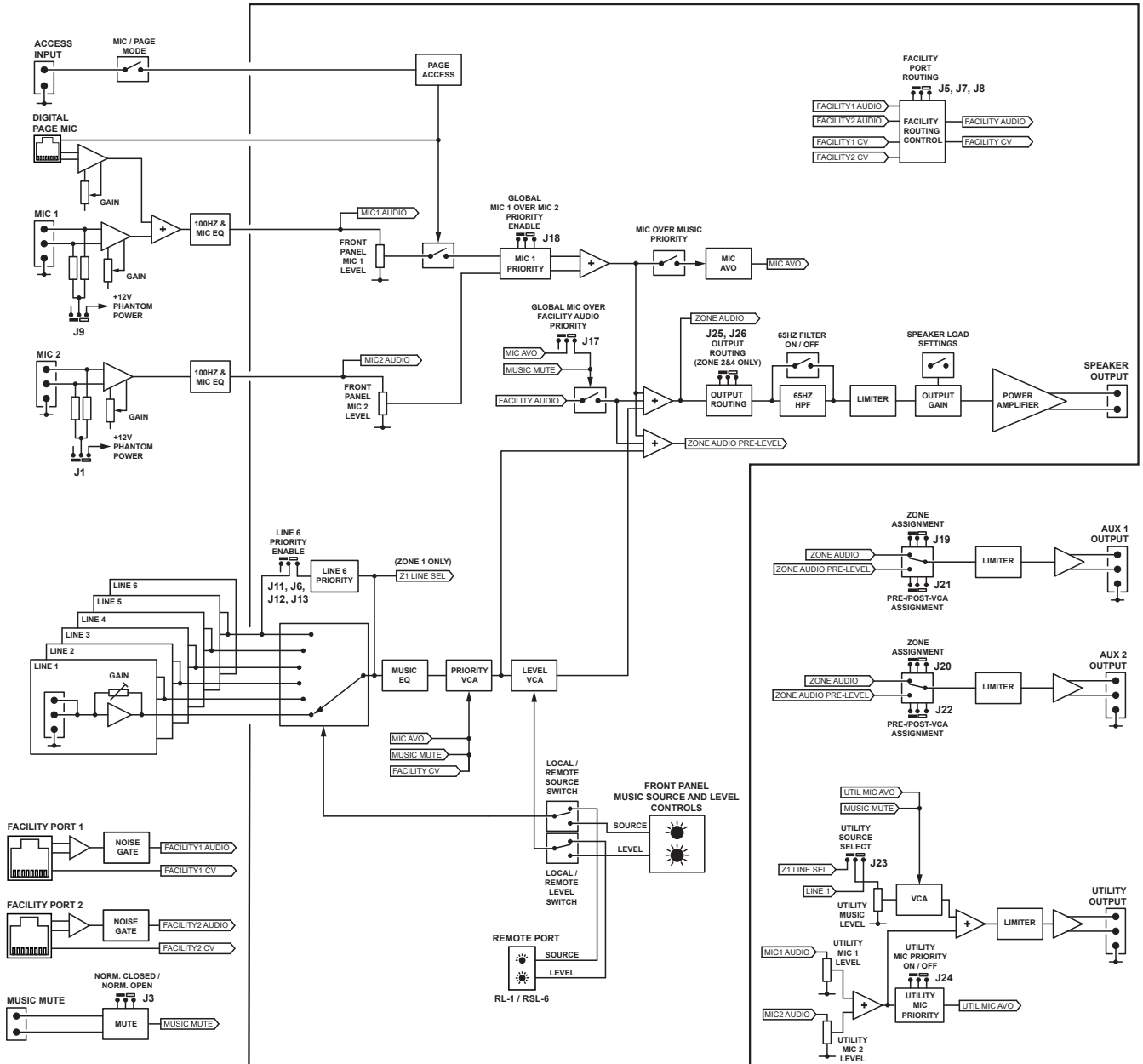

Front panel description

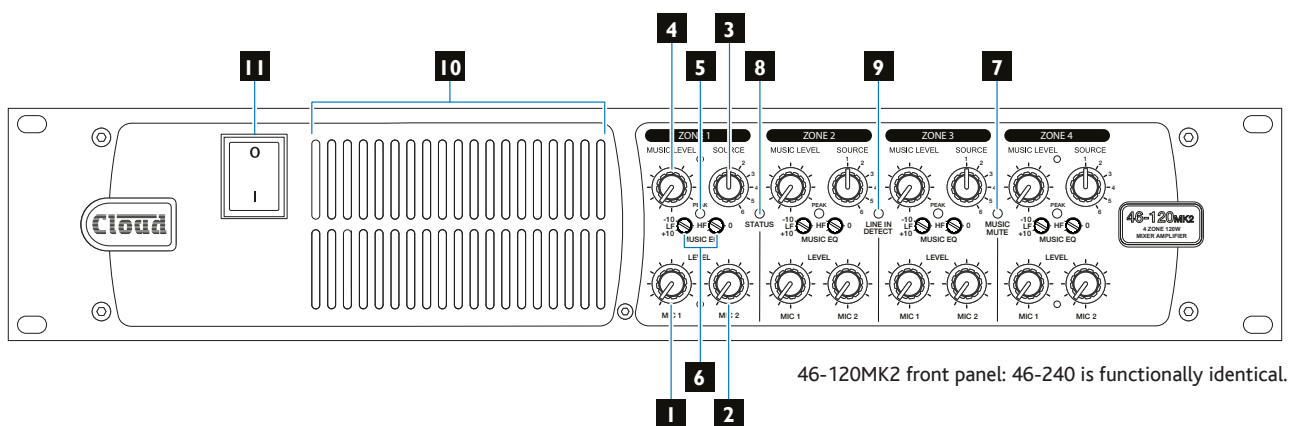

1. **MIC 1 LEVEL** – per-zone level controls for Mic 1 Input.
2. **MIC 2 LEVEL** – per-zone level controls for Mic 2 Input.
3. **SOURCE** – per-zone selection of active music source (Line Input 1 to 6).
4. **MUSIC LEVEL** – adjusts level of selected Line Input in each zone.
5. **PEAK** – per-zone red LED: illuminates if either Mic or Line signal levels are high enough to activate the zone’s output limiter.
6. **MUSIC EQ** – LF and HF EQ adjustment of music channel for each zone.
7. **MUSIC MUTE** – red LED: illuminates when external Music Mute is active.
8. **STATUS** – bicolour LED indicates as follows:

INDICATION	MEANING
Off	Power off
Green	Normal operating mode
Red	Standby (APD) mode
Flashing green	Power reduction due to high temperature
Flashing red	Fault condition - outputs muted

9. **LINE IN DETECT** – green LED; illuminates when an input signal is detected at any of the line inputs.
10. Forced air cooling intake slots – do not block.
11. Mains power switch

NOTE: Front panel items are referred to throughout this manual by numbers shown thus: **1**.

Rear panel description

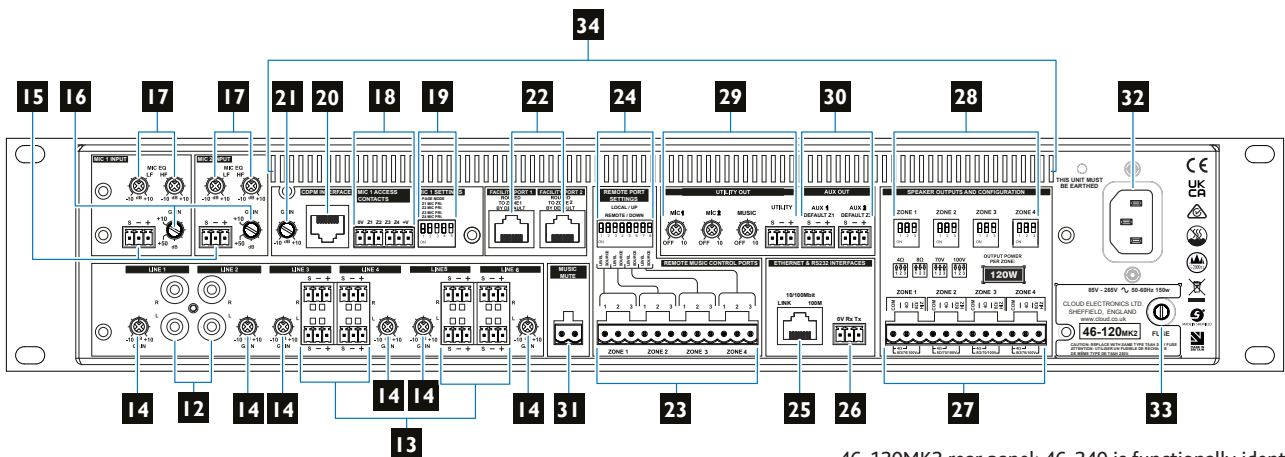

46-120MK2 rear panel: 46-240 is functionally identical.

- 12. LINE 1 and LINE 2 – unbalanced stereo line inputs for music sources.
- 13. LINE 3 to LINE 6 – balanced stereo line inputs for music sources.
- 14. GAIN 1 to GAIN 6 – level trims for each line input.
- 15. MIC 1 and MIC 2 INPUT – balanced inputs for microphones.
- 16. GAIN 1 and 2 – level trims for mic inputs.
- 17. MIC EQ – LF and HF EQ adjustment for each microphone.
- 18. MIC 1 ACCESS CONTACTS – external paging control port for Mic 1.
- 19. MIC 1 SETTINGS – 5-pole DIP switch for configuring paging operation:

SWITCH	NAME	FUNCTION
SW1	PAGE MODE	MIC 1 mode – configures the mic input for paging use
SW2	Z1 MIC PRI.	Enables mic-over-music priority in Zone 1
SW3	Z2 MIC PRI.	Enables mic-over-music priority in Zone 2
SW4	Z3 MIC PRI.	Enables mic-over-music priority in Zone 3
SW4	Z4 MIC PRI.	Enables mic-over-music priority in Zone 4

- 20. CDPM INTERFACE – RJ45 socket for connection of Cloud PM4/8/12/16 digital paging microphones.
- 21. GAIN – Input level control for CDPM mic.
- 22. FACILITY PORT 1 and 2 – RJ45 sockets for connection of remote active input/control modules such as the LM-2, BT-1, L-1 and M-1. These ports may alternatively be used as an additional balanced line input. By default, signals applied here are routed to Zones 1 and 2 respectively, but Facility Port 1 may be routed to all zones, or each port routed to two zones, by moving internal jumpers.
- 23. REMOTE MUSIC CONTROL PORTS – for connection of RL-1 or RSL-6 remote control plates.

24. **REMOTE PORT SETTINGS** – 8-pole DIP switch for setting Z1 to Z4 Local/Remote operation:

SWITCH	NAME	FUNCTION
SW1	Z1 LEVEL	Selects local/remote control of Z1 music level
SW2	Z1 SOURCE	Selects local/remote control of Z1 music source
SW3	Z2 LEVEL	Selects local/remote control of Z2 music level
SW4	Z2 SOURCE	Selects local/remote control of Z2 music source
SW5	Z3 LEVEL	Selects local/remote control of Z3 music level
SW6	Z3 SOURCE	Selects local/remote control of Z3 music source
SW7	Z4 LEVEL	Selects local/remote control of Z4 music level
SW8	Z4 SOURCE	Selects local/remote control of Z4 music source

25. **ETHERNET INTERFACE** – standard RJ45 10/100 Mbit/s network port: accepts TCP/IP commands to select or adjust various unit functions and parameters from an external AV control system.

26. **RS232 INTERFACE** – bi-directional RS-232 interface with same functionality as Ethernet port.

27. **SPEAKER OUTPUTS** – outputs for each zone – connect to either low-Z loudspeakers (4 or 8 ohms) or to 70/100 V-line distribution system.

28. **SPEAKER CONFIGURATION** – four 3-pole DIP switches for setting output configuration independently in each zone:

SWITCH	ZONE	FUNCTION
SW1	ZONE 1	Enables Z1 65 Hz high-pass filter (use with 70/100 V-line operation)
SW2		Configures Z1 output for low-Z (ON) or high-Z (70/100 V-line) operation (OFF)
SW3		With SW2 ON, selects Z1 output impedance to suit 4 ohm (OFF) or 8 ohm (ON) loudspeakers With SW2 OFF, selects 70 V-line (OFF) or 100 V-line (ON) operation for Z1
SW4	ZONE 2	Enables Z2 65 Hz high-pass filter (use with 70/100 V-line operation)
SW5		Configures Z2 output for low-Z (ON) or high-Z (70/100 V-line) operation (OFF)
SW6		With SW5 ON, selects Z2 output impedance to suit 4 ohm (OFF) or 8 ohm (ON) loudspeakers With SW5 OFF, selects 70 V-line (OFF) or 100 V-line (ON) operation for Z2
SW7	ZONE 3	Enables Z3 65 Hz high-pass filter (use with 70/100 V-line operation)
SW8		Configures Z3 output for low-Z (ON) or high-Z (70/100 V-line) operation (OFF)
SW9		With SW8 ON, selects Z3 output impedance to suit 4 ohm (OFF) or 8 ohm (ON) loudspeakers With SW8 OFF, selects 70 V-line (OFF) or 100 V-line (ON) operation for Z3
SW10	ZONE 4	Enables Z4 65 Hz high-pass filter (use with 70/100 V-line operation)
SW11		Configures Z4 output for low-Z (ON) or high-Z (70/100 V-line) operation (OFF)
SW12		With SW11 ON, selects Z4 output impedance to suit 4 ohm (OFF) or 8 ohm (ON) loudspeakers With SW11 OFF, selects 70 V-line (OFF) or 100 V-line (ON) operation for Z4

29. **UTILITY OUT** – balanced output with an independent mic/music mix: the music source can be set by internal jumpers. Suitable for use with loop amplifiers. The output has three associated preset level controls, **MIC 1**, **MIC 2** and **MUSIC**

30. **AUX OUT** – two per-zone balanced line level outputs for feeding additional amplifiers, etc. Default sources are Zone 1 and Zone 2 respectively, but may be modified by internal jumpers

31. **MUSIC MUTE** – Emergency control input for muting music.

32. IEC mains input.

33. Mains fuse.

34. Forced air cooling exhaust slots – do not block.

NOTE: Rear panel items are referred to throughout this manual by numbers in square brackets thus: **12**.

INSTALLATION

Hardware considerations

The 46 Series mixer-amplifier is built in a 2U-high 19" rack mount enclosure. It is recommended that it is installed in a 19" rack wherever possible. Both models are 430 mm deep: it is recommended that at least 100 mm of additional rack depth should be available to allow for rear connectors and cabling.

The choice of installation location will be dictated by the specifics of the system and building layout. It is recommended that wherever possible, the mixer-amplifier should be mounted adjacent to as many of the music sources (CD players, music servers, TV receiver boxes, etc.) as practical.

When deciding the mixer-amplifier's location, bear in mind that access to it (particularly the rear panel) will probably be required even if a full complement of remote controls is being fitted as part of the system, as certain adjustments can only be made on the unit itself.

Ventilation

46 Series mixer-amplifiers use both convection and forced-air cooling: at 45°C the internal fan is activated at low speed, it switches to high speed if the temperature exceeds 60°C.

In both models, air is taken in through ventilation slots in the front panel and exhausted through similar slots in the rear panel: ensure that both sets are kept unobstructed by cabling or any other items. It is recommended that a 1U blank panel is fitted above the mixer-amplifier to aid heat dissipation; slotted panels are not recommended as they defeat the action of forced-air cooling.

46 Series mixer-amplifiers have been designed to operate in an ambient temperature range of 0°C to 35°C. While satisfactory operation outside of this recommended temperature range may be achievable in a particular installation, no guarantee can be given regarding full adherence to the performance specifications (see the Appendix section of this manual). Installers should always endeavour to fit the mixer-amplifier in a location where the recommended temperature range is not exceeded. To help achieve this, we recommend that the unit is not rack-mounted immediately above other equipment which generates heat (e.g., older designs of power amplifier).

If the unit is to be used free-standing (i.e., not mounted in a rack), the push-rivet plastic feet supplied in the accessory pack should be fitted to the bottom of the enclosure.

Power Supply

46 Series mixer-amplifiers have an internal power supply of the "universal" type, and will operate on all AC mains supplies of between 85 V and 265 V, 45 to 65 Hz. An IEC mains cable with a plug appropriate for each country is supplied with the unit. The units are very energy-efficient and consume less than 10 W in Standby mode; see the Technical Specifications at page 31 for more details.

Fuses and ratings

The only externally-accessible fuse is the AC mains fuse adjacent to the IEC receptacle on the rear panel. Only replace a fuse with one of exactly the same type.

The table below gives the correct fuse type:

Model	Fuse Type	Fuse size	Rating
46-120MK2	T5AH 250V	20 mm x 5 mm	5 A
46-240	T8AH 250V	20 mm x 5 mm	8 A

If a replacement fuse blows immediately, it indicates that the mixer-amplifier has developed a fault, which should be referred to competent service personnel.

Internally, a 20 mm x 5 mm 2.5 A time-delay fuse protects each power supply module (two in Model 46-120MK2, four in Model 46-240). This is a service component, and should not require attention. Failure of this fuse indicates a fault condition, which should be immediately referred to a competent technician or authorised service centre.

Connections and Controls

Music Inputs

The unit has six stereo line inputs; these inputs are suitable for most music sources such as compact disc players, music servers, laptops, satellite receivers and the like. Each stereo input is summed internally to mono.

Two inputs – **LINE 1** and **LINE 2** - are unbalanced, and use standard phono sockets (RCA jacks) in pairs. **LINE 3** to **LINE 6** are balanced, and use pairs of 3-pin 3.5 mm-pitch screw terminal connectors. The input impedance for all line inputs is greater than 10 kohms. Connection to the balanced inputs should be as shown below:

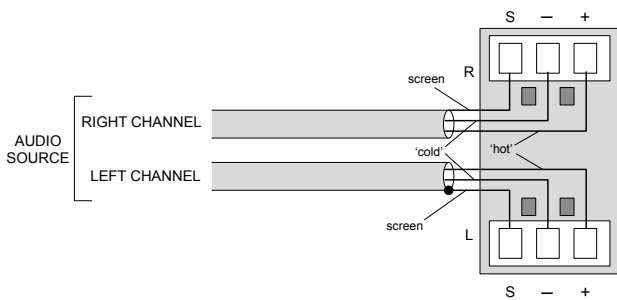

LINE 6 input can be configured to have automatic priority over the other music sources: see Music Priority, page 15

Sensitivity & Gain Control

All six stereo line inputs have a preset **GAIN** control on the rear panel adjacent to the respective input sockets. The gain control has a range of 20 dB allowing the input sensitivity to be varied from -12 dBu (195 mV) to +8 dBu (2.0 V).

The **GAIN** control should be adjusted so that all the input sources are operating at approximately the same volume, and that the front panel **MUSIC LEVEL** controls have a useful range of control.

The front panel is fitted with a green **LINE IN DETECT LED** 9, which is a useful aid to system set-up. It confirms that a music source signal is present at the unit inputs. The LED illuminates if a signal is present at any of the line inputs: note that the signal detection is post the rear panel **GAIN** controls, but pre the music EQ and level controls. The LED's threshold level is -30 dBu with the rear panel **GAIN** control set to 0 dB.

Music Source Select

Each of the four zones has a front panel **SOURCE** rotary switch, used to select the desired music signal for the zone. Remote control of source selection is possible with a remote control plate (RSL-6), or active input/remote control module (LM-2), see this page and page 21 respectively.

Music Level Controls

Four front panel mounted **MUSIC LEVEL** controls are provided, one for each zone.

Remote control of music level is possible with a remote control plate (RSL-6 or RL-1), or active input/remote control module (LM-2), see below and page 21 respectively

Remote Control of Music Source and Level

46 Series mixer-amplifiers are compatible with standard Cloud remote control plates: RSL-6 Series (music source select and level) and RL-1 Series (level only). Remote control is available independently in all zones.

Either type of plate may be connected at the four rear 3-pin, 5 mm-pitch screw terminal connectors (**REMOTE CONTROL MUSIC PORTS**), using the wiring shown below

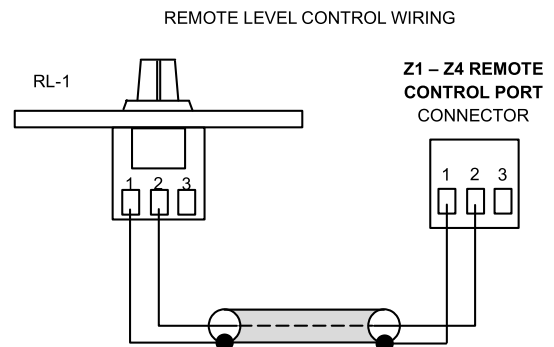

SINGLE-CORE SCREENED CABLE MAY BE USED

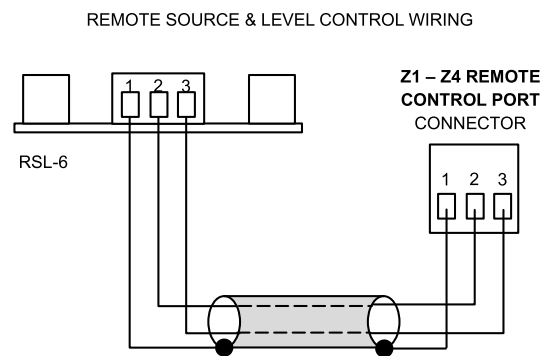

USE TWO-CORE SCREENED CABLE

Use two-core (RSL-6 or RL-1) or single-core (RL-1 only) screened cable to connect the remote level plate (max length 100 metres).

A bank of 8 DIP switches above the **REMOTE CONTROL MUSIC PORTS** connector controls whether music level and/or source control are assigned to the front panel controls or a remote control plate, independently for each of the four zones. If an RL-1 is being used in a zone, the **SOURCE** switch for that zone should remain in the **LOCAL** position (OFF), with the corresponding **LEVEL** switch set to **REMOTE** (ON), so that source selection remains under front panel control.

Music Equalisation

MUSIC EQ controls are provided for the music signals in each zone. These preset controls are located on the front panel below the **SOURCE** and **MUSIC LEVEL** controls **6**. The **LF** controls have a range of ± 10 dB at 50Hz and the **HF** controls have a range of ± 10 dB at 10 kHz.

Note that these controls do not affect a signal applied to the unit via the Facility Ports: see page 21.

Music Priority

A jukebox, digital sound store or other audio source can be given automatic priority over all other music inputs in some or all zones by connecting it to Line Input 6 and moving internal jumpers J11 (Zone 1), J6 (Zone 2), J12 (Zone 3) and/or J13 (Zone 4) from OFF (factory default position) to ON. When this priority is enabled, the unit will operate normally until a signal is detected at Line Input 6, when the selected source for a zone (typically background music) is muted, allowing the source connected to Line 6 to replace it. Once the signal at Line Input 6 stops, the selected source will smoothly restore to its former level over a period of 6 seconds. See page 27 for location of jumpers.

Note that Line 6 priority does not apply to the Facility Ports. Remote active modules connected to the Facility Ports will normally have priority (but in the case of the LM-2, see the Installation Guide supplied with the module for further information).

Microphone Inputs

Two microphone inputs are provided; the microphone pre-amplifiers utilise an electronically balanced, transformerless design configured for optimum low noise performance. The input impedance is 3.3 kohm and is suitable for microphones in the 200 ohm to 600 ohm range.

The inputs are via the 3-pin, 3.5 mm-pitch screw terminal **MIC 1 INPUT** and **MIC 2 INPUT** connector on the rear panel **15**.

Mic Input – connections

Mic Input 1 can be configured for paging or announcements independently in each zone. By default, the input is independent and is simply mixed with the selected line input: when reconfigured for paging, it operates as a standard Cloud-type paging input, with selectable mic-over-music priority and triggering by either contact closure or automatic signal detection. It is then compatible with paging microphones using zone selection by contact-closure such as the Cloud PM Series, including the PM1 single-zone microphone. See page 16 for more details.

Mic Input 2 is a general-purpose microphone input without paging capability. Internal jumper J18 can be set to control whether Mic Input 1 has priority over Mic Input 2 globally in all zones. The default setting of J18 is OFF; in this mode, the two mic inputs will mix together with no priority.

When SW1 of the **MIC 1 SETTINGS** DIP switch **19** is set to PAGE mode, Mic Input 1 will automatically assume priority over Mic Input 2, without the need to adjust internal jumper J18.

Connect microphones as shown below:

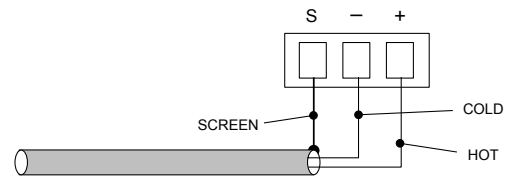

12 V phantom power is available at both mic inputs, and is activated by setting internal jumpers J9 (Mic Input 1) and/or J1 (Mic Input 2) to the ON position. See page 27 for locations of internal jumpers. Care should be taken to ensure that phantom power is activated only when the microphone connected to the input requires it – i.e., a capacitor or electret type; other types of microphones (such as dynamic) may be damaged if a DC voltage is applied to them.

Gain Control

Each mic input has a preset **GAIN** control **16** adjacent to the input connector. The **GAIN** controls have a range of 40 dB, from 10 dB to 50 dB.

Microphone level controls

Eight front panel **MIC LEVEL** controls are provided: these provide the user with a means of adjusting the volume of each mic independently in each zone. The rear panel **GAIN** controls should be set at a level where distortion does not occur even when a front panel **MIC LEVEL** control is fully clockwise. If the mic levels are set too high in a zone, the corresponding front-panel **PEAK LED** **5** will illuminate. Note that these LEDs also indicate excessive music level.

Microphone Equalisation

The microphone inputs are routed to the mixer stage via fixed high pass filters and adjustable EQ sections. The fixed filters attenuate the signals below 100 Hz, which helps to reduce the effects of microphone handling noise.

The two preset **MIC EQ** controls are on the rear panel **17** adjacent to the mic input; the **LF** and **HF** controls provide ± 10 dB of adjustment below 100 Hz and above 5 kHz respectively. After installation, some test announcements should be made, ideally by the people who will normally make them. The Mic EQ should be adjusted if necessary to maximise voice clarity.

Paging control and mic priority

Cloud PM Series paging microphones may be connected directly to 46 Series mixer-amplifiers. All models except the PM1 can use either the Cloud CDPM Digital Paging Interface, or an analogue interface comprising the **MIC1 INPUT** and **MIC 1 ACCESS CONTACTS** connectors. (Note that Model PM1 can only use the analogue interface.)

Internally, Mic 1 input and the CDPM port share the same signal path, so the following description applies to either input. Paging operation is configured with the rear panel 5-way **MIC 1 SETTINGS** DIP switch **19**. For normal (non-paging) microphone operation, all five switches should be in the 'up' position.

- **SW1 – PAGE MODE:** in the OFF position (switch up), Mic 1 input operates as a standard microphone input (MIC mode). In the ON position (switch down), it operates as a typical Cloud paging input (PAGE mode). In this mode, pins on the per-zone **MIC 1 ACCESS CONTACTS** connector will need to be shorted to 0V in order for the mic to become active.
- **SW2 – Z1 MIC PRI.:** set to ON to enable Mic-over-Music priority in Zone 1. This can be selected in both Mic Mode and Page Mode, i.e., regardless of the setting of SW1. In MIC mode the priority trigger is always VOX. i.e., the presence of a signal at the mic input will automatically trigger the priority function. In PAGE mode, priority is triggered by shorting of pins on the **MIC 1 ACCESS CONTACTS** connector for Zone 1. When active, the Mic-over-Music priority function will attenuate the level of signals at both Line and Facility Port inputs by 25 dB. When triggering is released, the music will fade up over approximately 3 seconds.
- **SW3 – Z2 MIC PRI.:** this switch performs the same function as described for SW2 in Zone 2.
- **SW4 – Z3 MIC PRI.:** this switch performs the same function as described for SW2 in Zone 3.
- **SW5 – Z4 MIC PRI.:** this switch performs the same function as described for SW2 in Zone 4.

Microphone Access Input

The paging access control input is on the 6-pin, 5 mm-pitch screw-terminal **MIC 1 ACCESS CONTACTS** connector **18**. This provides compatibility with "contact-closure" paging microphones, and allows announcements to be made in one or more zones. In PAGE Mode (SW1 down), the mic input is muted as long as any of the Z1 to Z4 pins are not connected to 0 V. When any of the Z1 to Z4 pins are connected to the 0V pin, Mic 1 input becomes active.

In both MIC and PAGE Modes, the music signal is faded back up after the announcement is complete over a period of approx. 3 seconds.

Connecting a PM4/4SA paging mic via the Cloud Digital Paging Interface

PM Series microphones are available in 4, 8, 12 or 16-zone versions; the PM-4 (or PM-4SA) is the appropriate model for use with the four-zone 46 Series.

46 Series mixer-amplifiers are fitted with a Cloud Digital Paging Interface; this uses a RJ45 socket and is indicated as the **CDPM INTERFACE** connector on the rear panel **20**. Cloud PM Series Paging microphones may be connected directly with Cat 5 cable; the single connection provides all audio, control and power required by the microphone.

The port is able to supply up to 100 mA to power paging microphones*. This is adequate to power a single PM-4 microphone. Cloud recommend that all '-SA' models (with spot announcement sound stores) are powered by a separate, external PSU, as described in the PM Series Installation Guide. (A suitable PSU is supplied as standard with all '-SA' models.)

Connect the **OUT** socket of the PM Series microphone to the **CDPM INTERFACE** socket on the mixer-amplifier with Cat 5 cable. The standard Cat 5/RJ45 wiring convention is shown below:

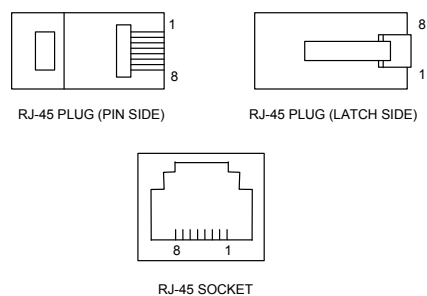

RJ45 PIN	CAT5
1	White + Orange
2	Orange
3	White + Green
4	Blue
5	White + Blue
6	Green
7	White + Brown
8	Brown

The CDPM Interface allows multiple PM Series microphones to be "daisy-chained". If more than one paging microphone is being installed – typically at different locations in the building, connect the **OUT** socket of one to the **IN** socket of the next.

IMPORTANT - Please refer to the PM Series Installation Guide for full information regarding maximum cable length, buss terminations and current requirements.

The earlier Cloud CDPM Series of paging microphones is also compatible with the Digital Paging Interface.

*NOTE: current capability may be slightly reduced if the MIC 1 ACCESS CONTACTS connector is also in use

Connecting a paging mic via the analogue interface

Two connections are required: the paging mic audio signal should be connected to the **MIC 1 INPUT** **15**, and the control cable to the 6-pin **MIC 1 ACCESS CONTACTS** port **18**. The pinout of this port is:

PIN	NAME	FUNCTION
1	0V	0 V
2	Z1	Connect to 0V to enable paging to Zone 1
3	Z2	Connect to 0V to enable paging to Zone 2
4	Z3	Connect to 0V to enable paging to Zone 3
5	Z4	Connect to 0V to enable paging to Zone 4
6	+V	+V _{supply} reference

Standard two-core screened audio cable may be used for the audio signal, and stranded six-core cable with an overall screen for the control cable. (Note that '-SA' versions of PM Series microphones cannot be powered by the 46 Series, and require an external PSU.)

If connecting a PM Series microphone via the analogue interface, use the rear cable access glands and screw terminal blocks on the microphone's internal PCB (**TERM1**, **TERM4** and **TERM8** in the example shown below). Full connection details and notes on power supply considerations can be found in the PM Series Installation and User Guide.

The diagram below shows both the cable connections between a PM4 and a 46 Series unit. Note that the DC power supply connection will not be required if the PM microphone is powered independently by a local PSU.

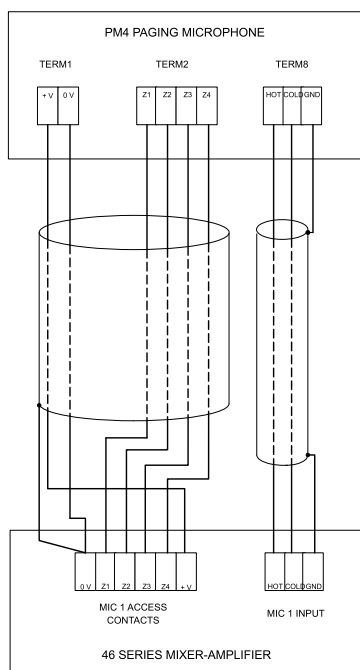

Connecting a Cloud PM1 paging mic

The PM1 is a simple, passive paging microphone suitable for situations where announcements are always made to the same zone(s). It can be connected directly to the analogue paging interface, the control cable being wired to the pin(s) of the **MIC 1 ACCESS CONTACTS** connector corresponding to the zone(s) in which announcements are required. Any or all of the zones may be paralleled if multiple zones need to operate from the PM1.

Either a single 2-pair individually-screened cable may be used (this gives the neatest finish), or two separate standard microphone cables. Note that the PM1 does not require DC power. Connections on the PM1 are made via the rear cable gland in the base and the screw terminal blocks on the internal PCB (U2 and U3). Full connection details can be found in the PM1 Installation and User Guide.

The diagram below shows the connections between a PM1 and a 46 Series mixer-amplifier. Use of 2-pair cable is assumed; the same wiring principle is adopted if separate cables are being used for audio and control.

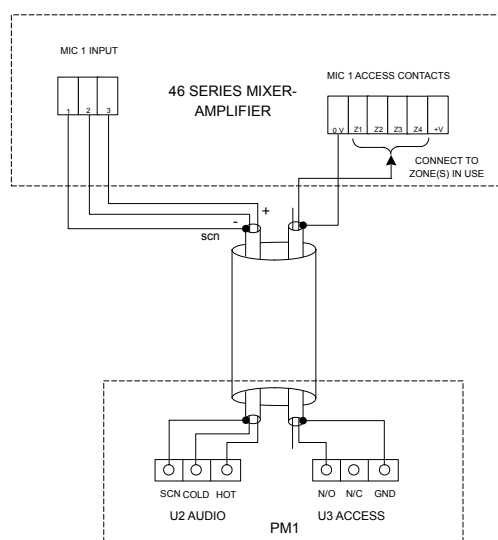

Outputs

Speaker Outputs

The power amplifier stages are fully protected against DC offset and output over-current, and also have two-stage thermal protection. Activation of the protection circuitry mutes the power amplifier stage until the fault condition clears. All protection conditions will automatically self-clear once the fault condition is removed, or if the amplifier is power-cycled. The exception to this is muting due to detection of DC at the output terminals, which will require manual power-cycling to clear. A switch-on delay function mutes the output during power-up and power-down to protect loudspeakers.

Each zone of a 46 Series mixer-amplifier has both a low impedance output (4 or 8 ohms) and a high voltage output for 70/100 V-line speaker systems. Both output types are available on the four 3-pin 5 mm-pitch screw-terminal **SPEAKER OUTPUTS** connectors **27**. The four zones may be configured independently, but in each zone, only one output option can be used at a time. The output type is selected with **SPEAKER CONFIGURATION** DIP switch **28**; see details below.

The following connection notes apply to each of the four zone outputs.

Connecting to Lo-Z loudspeakers

For low-impedance operation, set SW2 to ON (switch down). The mixer-amplifier can deliver its rated power into a 4 ohm or 8 ohm load: set SW3 up (4 ohms) or down (8 ohms) as appropriate. Installers fitting multiple low-impedance loudspeakers (generally 8 ohms) should employ series and parallel wiring to produce, where possible, a total load impedance of either 4 or 8 ohms.



IMPORTANT: Under no circumstances should the total load impedance be less than the output impedance selected with SW3 (i.e., 4 or 8 ohms).

For low-impedance operation, wire the **SPEAKER OUTPUT** connector according to (a) or (b) in the diagram below.

Connecting to 70/100 V-line systems

46 Series mixer-amplifiers' output stages use a transformerless design which can directly drive 70 V-line or 100 V-line loudspeaker systems. The power amplifier stage is rated at 120 W per-zone (Model 46-120MK2) or 240 W per zone (Model 46-240).

Connect to a 70 V-line or 100 V-line speaker system by setting SW2 to high-Z (switch up) and setting SW3 either up for 70 V-line operation, or down for 100 V-line operation, as required: see (c) in the diagram below. Note that units will be factory-set for 100 V-line operation "out of the box"..

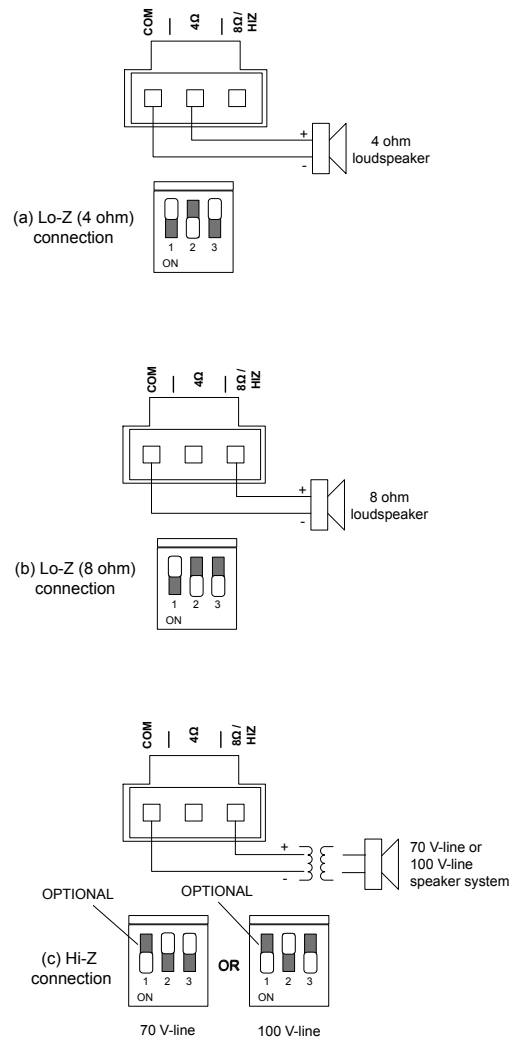

When driving 70/100 V-line loudspeaker systems there is a risk of transformer core saturation at high levels and low frequencies, which can produce distortion. To prevent this, the mixer-amplifier's output stages are provided with a 65 Hz high-pass filter, which may be enabled by setting **SPEAKER CONFIGURATION** switch SW1 to ON (switch down).

Power Sharing (Model 46-120MK2 only)

Model 46-120MK2 incorporates the principle of Power Sharing when the outputs of Zones 1 and 3 and/or Zones 2 and 4 are configured for Hi-Z mode (i.e., for 70/100 V-line operation). The maximum power available for ZONE 1 and ZONE 3 combined is 240 W; the maximum power available for ZONE 2 and ZONE 4 combined is also 240 W. Each zone output is capable of delivering 240 W, but this figure can only be realised if the other zone output in the odd- or even- pair is unused.

Power Sharing is configured by adjusting the power tapping (wattage setting) on all 70 V-line or 100 V-line speakers. In each zone, the tappings should be set to give the required total wattage (e.g., Zone 1: 40 W total, Zone 3: 200 W total). The power sharing between the zones in the same odd- or even-numbered pair can be any ratio, provided the total wattage rating for both zones does not exceed 240 W.

The great advantage of power sharing is that it allows installers to use one zone output to drive speakers where only low power is needed, and the other for areas where more is needed.

Parallel power stage operation

46 Series mixer-amplifiers may be configured so that one zone signal (mix of music and mics) is routed to two output stages "in parallel". This gives the installer the additional flexibility of obtaining more power to drive the loudspeakers in a single zone. This may be particularly useful with Model 46-240, which lacks the Power Sharing capability of the 46-120MK2.

Note that parallel operation will reduce the total number of zones that can be catered for to either three or two.

Parallel power stage operation is configured by moving internal jumpers J25 and/or J26. By default, the pre-amplifier stages of Zones 1 to 4 are routed to the power output stages of Zones 1 to 4 respectively. Moving J25 from its default setting of 'Z3' to 'Z1' will route the output of Zone 1's pre-amplifier stage to the input of Zone 3's output stage as well as to Zone 1's output stage. Similarly, moving J26 from its default setting of 'Z4' to 'Z2' will route the output of Zone 2's pre-amplifier stage to the input of Zone 4's output stage as well as to Zone 2's output stage.

Parallel power stage operation is available on both the 46-120MK2 and 46-240, and is independent of the 46-120MK2's Power Sharing capability described in the preceding section

Auxiliary Outputs

46 Series mixer-amplifiers are provided with two assignable auxiliary outputs: these are available on the **AUX 1** and **AUX 2** connectors **30**. These may be used to drive additional amplifiers, for recording, or any other purpose where system “expansion” is required. The connectors are 3-pin, 3.5 mm-pitch screw terminal types.

By default, the output signals at **AUX 1** and **AUX 2** are derived from the mic/music mixes for Zone 1 and Zone 2 respectively. This assignment can be changed by moving internal jumpers J19 and/or J20. Move J19 from Z1 to Z3 to source Aux 1 with Zone 3’s mix. Move J20 from Z2 to Z4 to source Aux 2 with Zone 4’s mix.

It is also possible to define whether the signals at the auxiliary outputs are derived pre- or post-the front panel level controls. By default, the mix is that set up for the assigned zone by the front panel level controls (or via any of the various remote control options). Moving internal jumpers J21 (Aux 1) and/or J22 (Aux 2) allow the music signal to be derived pre the zone’s music level control. This is desirable in situations where a fixed-level music signal at the auxiliary output is required.

The auxiliary outputs are impedance balanced and line level, and can thus be used to drive most external equipment directly. The wiring is as follows:

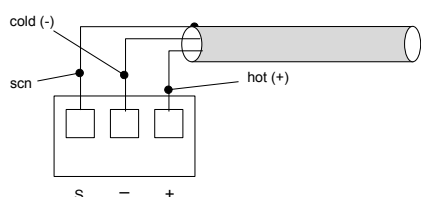

AUX OUTPUT: BALANCED CONNECTION

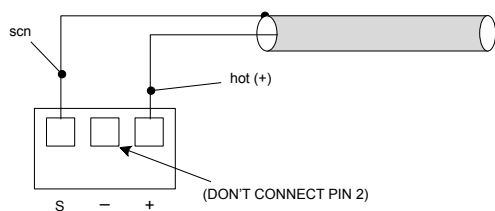

AUX OUTPUT: UNBALANCED CONNECTION

Note that the signals at the auxiliary outputs are not subject to the action of the 65 Hz high-pass filter. However, the Mic EQ and Music EQ controls are effective on the Auxiliary Output mix (for the mic and music components of the mix respectively).

Utility Output

46 Series mixer-amplifiers also have a Utility output, which is ideal for providing the feed to a loop amplifier, or for connection to low-power amplifiers driving speakers in secondary areas such as corridors or toilets. It is an impedance-balanced, line level signal available at the **UTILITY** connector **29**, which is a 3-pin, 3.5 mm-pitch screw-terminal type.

The Utility output can have an independent mix of music and mic signals: the mix is adjusted with the rear panel **MIC 1**, **MIC 2** and **MUSIC** preset controls adjacent to the **UTILITY** connector. By default, the music source will be that selected for Zone 1 – either by the front panel Zone 1 **SOURCE** control, or via remote control. Alternatively, the Utility output music source may be set to be permanently that connected to Line Input 1: this is done by moving internal jumper J23 from Z1 to LINE1. When J23 is set to Z1 (the default), the Utility Output will obey Line 6 Priority, if it is enabled. If J1 is set to LINE1, it will not be affected by Line 6 Priority.

Additionally, internal jumper J24 determines whether a mic signal (Mic 1 and/or Mic 2) at the Utility Output should cause the selected music signal being fed to the Utility Output to duck, the default being OFF (i.e., no ducking will occur). See page 27 for details of PCB jumper locations.

Note also that the levels of the mic signals in the Utility output mix are not affected by the front panel **MIC LEVEL** controls.

Facility Ports

46 Series mixer-amplifiers are provided with two **FACILITY PORTS** in the form of rear panel RJ45 connectors **22**. The primary use of the Facility Ports is for the connection of remote active modules such as the LM-2 or BT-1. The Facility Port audio path includes a noise gate to help minimise unwanted background noise from the external source.

If Mic-over-Music priority is enabled (see “Paging control and mic priority” on page 16), the position of internal jumper J17 determines whether an input at either Facility Port will be reduced in level by 25 dB in the same way as the other Line Inputs. By default, this ducking option is not enabled, but may be overridden by moving internal jumper J17 from its default setting (OFF) to ON. See page 27 for locations of PCB jumpers.

By default, an audio source connected to an active module will be routed via Facility Port 1 to Zone 1, and via Facility Port 2 to Zone 2. The music sources currently selected in those zones will be muted and replaced by the Facility Port audio. The Facility Port routing may be altered by moving internal jumpers J5, J7 and J8 as follows:

- J7 determines whether audio at Facility Port 1 is routed to all zones or only to Zones 1 and/or 3;
- in the latter case (above), J5 sets whether it is routed to Zone 1 or Zone 3;
- J8 determines whether audio at Facility Port 2 is routed to Zones 2 and/or 4.

Remote control functions via the Facility Ports

The remote control functions (music source and level) of an LM-2 active module connected to Facility Port 1 will only control Zone 1, even if Facility Port 1 is routed to multiple zones via jumpers J5 and J7.

The remote control functions (music source and level) of an LM-2 connected to Facility Port 2 will only control Zone 2, unless Facility Port 1 has been routed to all zones. In this scenario, the remote controls of the LM-2 connected to Facility Port 2 will be disabled.

Where a Facility Port is routed to more than one zone and it is desired to have remote RSL-6 or RL-1 control of source and/or level in the zones which are not controlled by the LM-2 remote control functions, then this can be achieved using the **REMOTE PORT** for the additional zone(s) to connect separate RSL-6 or RL-1 remote controls.

The various optional Cloud remote active modules operate from DC power supplied by the 46 Series mixer-amplifier. The current consumed by each module is minimal and in the vast majority of installations there will be no power supply issues.



IMPORTANT: In order for the remote control functions on an LM-2 module to operate (with J7/J8 in the default settings), the Zone 1 and/or Zone 2 rear panel **REMOTE PORT SETTINGS** DIP switches must be set to REMOTE. This will disable the front panel **SOURCE** and **MUSIC LEVEL** controls, and control of music level and/or source selection will be available from the LM-2. LOCAL/REMOTE selection should be left in LOCAL (switch up) when a BT-1, L-1 or M-1 module is connected to the Facility Port. However, if an RL-1 or RSL-6 remote control plate (or serial control of source and/or level) is also being used in these zones, the switch should be set to REMOTE.



IMPORTANT: Do not connect BOTH an LM-2 module (or an RSL plate connected via a BT-1 module) to a Facility Port AND an RL or RSL Series plate to a **REMOTE MUSIC CONTROL PORT** for the same zone that the Facility Port is routed to, as the remote controls will conflict.



IMPORTANT: If a Facility Port is assigned to more than one zone, the remote control functions only work on the lowest-numbered zone that it is assigned to. So remote control functions via Facility Port 1 can only ever control Zone 1 and remote control functions via Facility Port 2 can only ever control Zone 2, unless Facility Port 1 is assigned to all zones, in which case Facility Port 2 becomes redundant.

The pinout of the Facility Port connector is given in the table below:

PIN	USE	Cat 5 CORE*
1	Audio 'cold' phase (-)	White + Orange
2	Audio 'hot' phase (+)	Orange
3	Priority VCA control	White + Green
4	+ 12 V	Blue
5	0 V	White + Blue
6	-12 V	Green
7	Music level control (0 to 10 V)	White + Brown
8	Music source select control (0 to 10 V)	Brown
SCN	GND ref for system music controls	Connector shell

* Standard wiring for pre-made cables

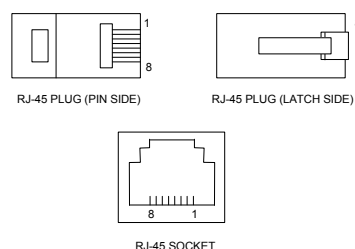

Connecting an active remote module

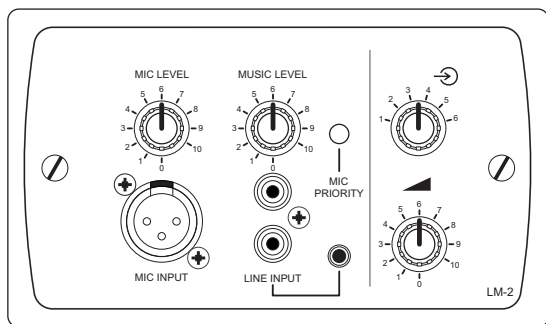

LM-2 mic/line input module, with music source and level controls

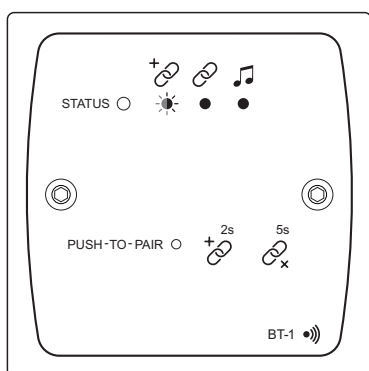

BT-1 Bluetooth wireless audio input module

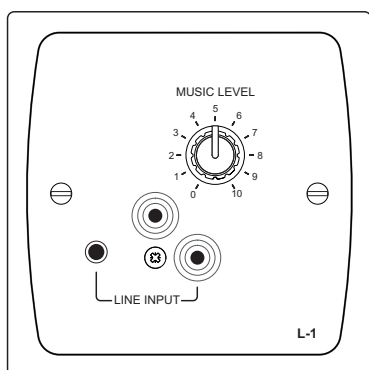

L-1 line input module

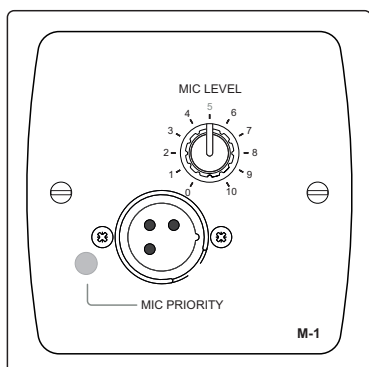

M-1 mic input module

LM-2: The LM-2 is an active input module which allows a microphone and a stereo line input in a remote location to be connected to the 46 Series mixer-amplifier. The module also includes the functions of a Cloud RSL-6 Remote Control Plate, which allows remote control of music level and music source selection in a zone (see notes above re Facility Port routing).

BT-1: The BT-1 is a Bluetooth remote audio input module which enables compatible portable devices such as laptops, tablets and smartphones to stream audio wirelessly to the module, and thus into the audio system feeding one or more zones (see notes above regarding Facility Port routing). It is also possible to connect an RL or RSL Series remote control plate to a BT-1, to allow control of music source and level via the same Facility Port.

NOTE: 46 Series units are only compatible with the BT-1F variant of the BT-1; do not attempt to connect variant BT-1E).

L-1/M-1: The L-1 and M-1 are remote active input modules which allows a microphone (M-1) or stereo line level source (L-1) to be connected within a zone and then routed to the zone's audio system. The M-1 includes a mic level control and a switchable mic-over-music priority function; the L-1 is fitted with both phono sockets (RCA jacks) and a 3.5 mm 3-pole jack socket, together with a music level control.

Active remote modules should be connected to a 46 Series **FACILITY PORT** using screened Cat 5 or Cat 6 cable. (Note that as the cable carries analogue audio, only screened Cat 5/6 should be used.) The LM-2 includes controls for local music level and source selection, the wiring for these functions being catered for on the Facility Port. The maximum total Cat 5 cable length should not exceed 100 m.

Connections:

LM-2: The LM-2's upper PCB is fitted with an RJ45 connector labelled **OUTPUT**. Connect this to a **FACILITY PORT** using screened Cat 5/6 cable with screened RJ45 connectors at each end. Follow the colour coding shown in the table on page 21. The metal screening of the connectors should be bonded to the screen of the cable. Full details can be found in the LM-2 Installation Guide.

As explained in the preceding section, before the LM-2's music source and level controls will operate, the appropriate **REMOTE PORT SETTINGS** DIP switches **24** for the respective Zone must be set to REMOTE. For Facility Port 1, this will be Zone 1; for Facility Port 2 it will be Zone 2, unless Facility Port 1 is routed to all zones.

BT-1: Connect the RJ45 socket on the rear of the BT-1 to a **FACILITY PORT** with *screened* Cat 5/6 cable and shielded RJ45 plugs. Full details can be found in the BT-1 Installation Guide.

M-1 and L-1: Connect the RJ45 socket on the rear of the M-1 or L-1 to a **FACILITY PORT** with *screened* Cat 5/6 cable and shielded RJ45 plugs. Full details can be found in the Installation Guide supplied with the module.

Music Mute (Fire Alarm Interface)

In some installations (such as licensed premises or retail outlets within a shopping mall), there may be a local authority or fire service requirement to mute the music signals from a fire alarm control panel when an alarm condition arises. 46 Series mixer-amplifiers include a facility to mute the music signals only (i.e., mic inputs are still active), via the **MUSIC MUTE** input. This is a 2-pin 5 mm-pitch screw terminal connector **31** on the rear panel.

Activation of the Music Mute is often via a relay mounted close to the mixer-amplifier, powered by the fire alarm control panel. Other arrangements may exist depending on the design of the fire control system and the alarm system details should be consulted when making the connection. The **MUSIC MUTE** input is non-isolated and connection should only be made to isolated contacts such as on a relay or mechanical switch. The mixer-amplifier will mute the music on either a contact closure at the Music Mute input (N/O) or an open-circuit (N/C). Selection of N/O or N/C operation is made with internal jumper J3. N/O is the factory default.

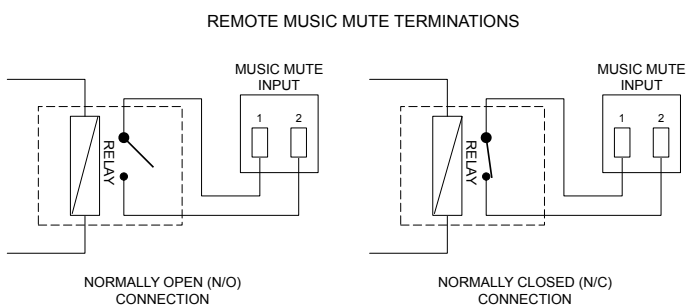

Note that any signal applied to a Facility Port – either from a remote active module, or as a hard-wired direct input, will also be muted by the action of Music Mute.

When Music Mute is active, the front panel red **MUSIC MUTE** LED **7** illuminates.

Auto Power Down

A Cloud 46 Series mixer-amplifier is extremely energy-efficient, but can be made even more so by enabling the Auto Power-Down feature. When active, the signal level is constantly monitored and if no signals are detected at a zone output for 15 minutes, the unit will determine whether that channel can enter Standby mode, to minimise power consumption. The precise behaviour differs slightly between the two models:

- Model 46-240: each of the four zone output stages can enter and exit Standby mode individually; signal presence is determined solely by the monitoring of that zone.
- Model 46-120MK2: the odd- and even- zone pairs always enter and exit Standby mode together. This means for example, that Zone 1 and Zone 3 must both be idle before they can be put into Standby mode, and that renewed signal presence in either Zone 1 or Zone 3 will result in both being “woken up”.

If a signal is detected while in Standby Mode, the unit “wakes up” in approximately two seconds.

Units are shipped with the Auto Power Down function disabled. It may be enabled by removing internal jumper J10. See page 27 for location of PCB jumpers

Options and Additional Information

Control of music source and level via external DC

It may be necessary in some installations to adjust the music level and select music source in one or more zones from an external AV control system. If the **REMOTE MUSIC CONTROL PORTS** are not required for RL-1/RSL-6 Series remote control plates, they may be used to receive DC voltages from the external system to effect these adjustments.

Both music source selection and level can be controlled over their full ranges with a DC voltage of 0 to +3.3 V. The pinout of each **REMOTE MUSIC CONTROL PORT** is as follows:

PIN	USE
1	0 V ref.
2	Music level control (0 to +3.3 V)
3	Music source selection (0 to +3.3 V)

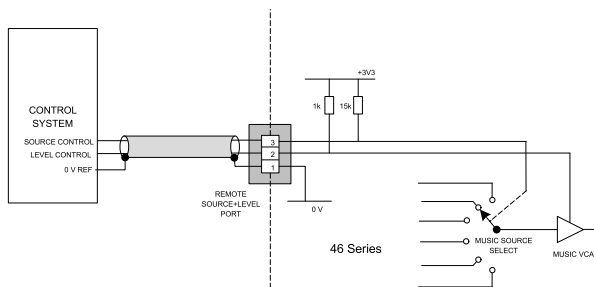

NOTE: If the control voltage source is not isolated from the power earth, there is a small risk of creating a 'ground loop' by linking the mixer technical ground (0 V) to the ground (0 V) of the equipment supplying the control voltages. To minimise this risk, we suggest that all pieces of equipment be in close proximity, and supplied from the same power outlet.

Music level

Music level in a zone may be varied over its full range by applying a DC voltage of between 0 V and +3.3 V to pin 2, the 0 V reference being connected to Pin 1. 0 V on pin 2 corresponds to maximum level and +3.0 V will produce 90 dB of attenuation. The rate of attenuation is approximately 33 mV/dB.

Note that there is an internal 1k "pull-up" resistor between pin 2 and the internal +3.3 V rail. If pin 2 is left "floating", this pull-up will result in full attenuation. The output impedance of the control voltage source should be low enough to overcome the effect of this resistor.

Music source

Music source for a zone may be controlled by applying various DC voltages of between 0 and +3.3 V to pin 3, the 0 V reference being connected to pin 1. A voltage of between

+1.5 v and +1.8 V at pin 3 will select Line input 1 and one of 0.17 V or less will select Line input 6. The other line inputs will be selected with intermediate voltages. Taking pin 3 above +2 V will deselect all inputs, making the zone effectively 'off' for music.

The table below lists the DC voltages required at pin 3 to select each line input. The third column is the value of a resistor which should be connected between pins 1 and 3 to permanently 'force' a zone to a particular line input.

INPUT	DC VOLTAGE	RESISTOR VALUE*
OFF	3.3 v	Open-circuit
Line 1	1.71 v	16k2
Line 2	1.37 v	10k7
Line 3	1.0 v	6k8
Line 4	0.69 v	4k02
Line 5	0.35 v	1k8
Line 6	0 v	Short-circuit

* resistors from the IEC E96 range ($\pm 1\%$) are recommended

Note that there is an internal 15k "pull-up" resistor between pin 3 and the internal +3.3 V rail. If pin 3 is left "floating", this pull-up will cause 'OFF' to be selected. The output impedance of the control voltage source should be low enough to overcome the effect of this resistor.

46 SERIES SERIAL CONTROL

46 Series mixer-amplifiers are equipped with both an Ethernet port and a bi-directional RS-232 serial interface, which permit remote control of numerous mixer-amplifier functions using serial commands.

The full serial protocol is beyond the scope of this manual, but is available for download from www.cloud.co.uk. This section provides only RS-232 port details and an abridged serial command list.

As a receiver, the interfaces permit external control of many mixer-amplifier settings. These include:

- Music Source selection in each zone
- Music level control in each zone
- Mic level control in each zone
- Mic muting in each zone

Note that the rear panel REMOTE PORT SETTINGS switches **24** must be set to REMOTE to enable serial remote control of music level and source.

Ethernet port:

This is a standard bidirectional Ethernet network port using an RJ45 socket. It can operate at data rates of 10 or 100 Mb/s; the rate is auto-negotiated. It permits the mixer-amplifier unit to respond to commands sent as TCP/IP data from third-party control systems. Commands are sent and responses received, via a connection to TCP port 4999.

RS-232 port:

The mixer-amplifier appears as a DCE (Data Communications Equipment) device to controlling equipment. As the controlling device will probably be configured as a DTE device, this requires the use of a straight (uncrossed) cable with the Tx (Data Transmit) pins at the cable ends connected to each other and the Rx pins (Data Receive) similarly connected to each other.

The RS-232 port parameters are detailed in the table below:

Parameter	VALUE/SETTING
Data type:	RS-232 serial
Data speed	9600 baud*
Word length	8 bits
Parity	None
Stop bits	One

*The default baud rate of 9600 baud may be altered by sending the appropriate RS-232 commands; details are in the RS-232 protocol document.

Abridged command set

The commands listed in the table below are some of those most commonly required when controlling a 46 Series mixer-amplifier from an AV control system. For all other commands, data requests and responses, please refer to the 46 Series' full serial protocol document.

GENERAL FORMAT	
FUNCTION	COMMAND (ASCII)
Route Line Input <i>x</i> to Zone <i>y</i>	<Z <i>y</i> .MU, S <i>x</i> />
Set music level in Zone <i>y</i> to <i>-m</i> dB	<Z <i>y</i> .MU, L <i>m</i> />
Reduce music level in Zone <i>y</i> by <i>p</i> dB	<Z <i>y</i> .MU, LD <i>p</i> />
Increase music level in Zone <i>y</i> by <i>q</i> dB	<Z <i>y</i> .MU, LU <i>q</i> />
Mute mic <i>a</i> input for Zone <i>y</i>	<Z <i>y</i> .Ma1, M/>
Unmute Mic <i>a</i> input for Zone <i>y</i>	<Z <i>y</i> .Ma1, O/>
Set level of both mic inputs in Zone <i>y</i> to <i>-m</i> dB	<Z <i>y</i> .MI, L <i>m</i> />
Reduce level of both mic inputs in Zone <i>y</i> by <i>p</i> dB	<Z <i>y</i> .MI, LD <i>p</i> />
Increase level of both mic inputs in Zone <i>y</i> by <i>q</i> dB	<Z <i>y</i> .MI, LU <i>q</i> />

Examples

1. Music source selection:

The values of x and y in the general format are the Line Input No. (1 to 6) and the Zone No. (1 to 4) respectively..

EXAMPLE	COMMAND (ASCII)	COMMAND (HEX)
Select Input 3 in Zone 2	<Z2 .MU , S3/>	3C 5A 32 2E 4D 55 2C 53 33 2F 3E

2. Music levels:

Levels can either be set in a specified zone to an absolute value (in dBs), or increased/decreased by a specified number of dBs. Either may be defined in steps of 1 dB.

For absolute levels, the number of dBs corresponds to attenuation rather than gain, thus 0 dB is maximum level and at -90 dB the zone is muted. The values of y in the general format is the Zone No. (1 to 4) and m is the attenuation level in one-dB steps (0 to 90) respectively.

To alter the zone level by a specified amount, the additional ASCII characters 'U' (up) or 'D' (down) are added to the string. The values of y , p and q in the general format are the Zone No. (1 to 4), the level increase in one-dB steps (0 to 90), or the level decrease in one-dB steps (0 to 90) respectively. A command to increment the level by a number of dBs greater than the current attenuation will set the level to maximum. Similarly, a command that would decrement the level below 90 dB attenuation will mute the Zone output.

EXAMPLE	COMMAND (ASCII)	COMMAND (HEX)
Set level in Zone 2 to -12 dB	<Z2 .MU , L12/>	3C 5A 32 2E 4D 55 2C 4C 31 32 2F 3E
Reduce level in Zone 1 by 10 dB	<Z1 .MU , LD10/>	3C 5A 31 2E 4D 55 2C 4C 44 31 30 2F 3E
Increase level in Zone 2 by 6 dB	<Z2 .MU , LU6/>	3C 5A 32 2E 4D 55 2C 4C 55 36 2F 3E

3. Mute/Unmute Mics

The 46 Series mixer-amplifier's mic inputs may be individually enabled or disabled. This may be done on a per-zone basis or globally (all zones). Note the character following 'M' may take the values '1' (Mic 1), '2' (Mic 2) or 'l' (both mics).

EXAMPLE	COMMAND (ASCII)	COMMAND (HEX)
Mute mic in Zone 2 only	<Z2 .M1 , M/>	3C 5A 32 2E 4D 31 2C 4D 2F 3E
Unmute mic in Zone 2 only	<Z2 .M1 , O/>	3C 5A 32 2E 4D 32 2C 4F 2F 3E
Mute both mic inputs globally	<MI , M/>	3C 4D 49 2C 4D 2F 3E
Unmute both mic inputs globally	<MI , O/>	3C 4D 49 2C 4F 2F 3E

APPENDIX

PCB jumper locations

46 Series mixer-amplifiers have various internal jumpers, the setting of which may require alteration during installation. The diagram below (not to scale) shows the locations of the internal jumpers, all of which except J3, J15 and J16 are located on the sub board mounted above the lower main PCB. J3, J15 and J16 are on the main PCB. The table below lists each jumper and its purpose, together with the factory default setting.

All "user" jumpers have two possible positions; the black rectangle in the symbol on the diagram below indicates the default setting. If any jumpers need to be changed, turn the unit off and disconnect it from the mains. Undo the twelve screws securing the top cover of the unit and remove it. Use a pair of small pliers to gently remove the jumpers from the PCB headers and reposition them as required. Refit the top cover using the same screws.

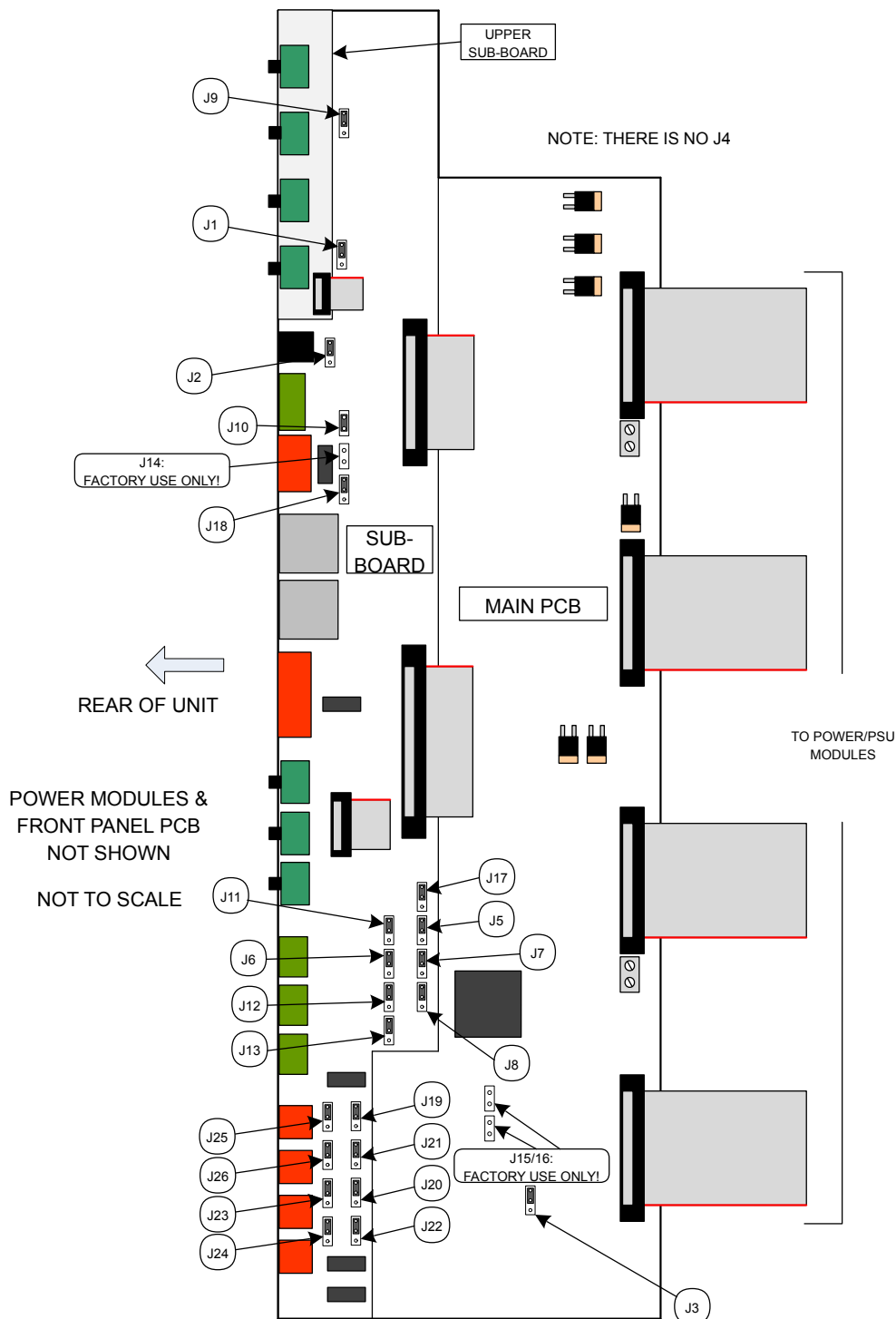

Table of internal jumpers and default settings

The table below lists each jumper and its purpose, together with location and factory default setting.

JUMPER	DESCRIPTION	EFFECT	DEFAULT
J1	Mic Input 2 phantom power	OFF: Mic Input 2 phantom power off. ON: 12 V phantom power available at Mic Input 2.	OFF
J2	CDPM bus termination	OFF: CDPM bus is not terminated within the unit. ON: CDPM bus termination is on.	ON
J3	Music mute N/O or N/C	N/O: connect the pins of the MUSIC MUTE connector together to mute Line Inputs 1 to 6 and the Facility Port. N/C: remove a short-circuit across the pins of the MUSIC MUTE connector to mute Line Inputs 1 to 6 and the Facility Port.	N/O
J4	Not present		
J5	Facility Port 1 audio routing	Z1: Audio input at Facility Port 1 is routed to Zone 1 only. Z1&Z3: Audio input at Facility Port 1 is routed to Zone 1 and Zone 3. NOTE: This jumper is only effective with J7 set to OFF.	Z1
J6	Zone 2 Line 6 Priority	OFF: Line Input 6 operates as other line inputs in Zone 2. ON: a signal at Line Input 6 will take priority in Zone 2 over all other Line Inputs, but not over the Facility Port.	OFF
J7	Facility Port 1 All Zones	OFF: Routing of audio input at Facility Port 1 is set by J5 ON: Audio input at Facility Port 1 is routed to all zones	OFF
J8	Facility Port 2 audio routing	Z2: Audio input at Facility Port 2 is routed to Zone 2 only. Z2&Z4: Audio input at Facility Port 2 is routed to Zone 2 and Zone 4.	Z2
J9	Mic Input 1 phantom power	OFF: Mic Input 1 phantom power off. ON: 12 V phantom power available at Mic Input 1.	OFF
J10	APD disable	PRESENT: APD (Automatic Power Down) inactive. ABSENT: APD enabled	PRESENT
J11	Zone 1 Line 6 Priority	OFF: Line Input 6 operates as other line inputs in Zone 1. ON: a signal at Line Input 6 will take priority in Zone 1 over all other Line Inputs, but not over the Facility Port.	OFF
J12	Zone 3 Line 6 Priority	OFF: Line Input 6 operates as other line inputs in Zone 3. ON: a signal at Line Input 6 will take priority in Zone 3 over all other Line Inputs, but not over the Facility Port.	OFF
J13	Zone 4 Line 6 Priority	OFF: Line Input 6 operates as other line inputs in Zone 4. ON: a signal at Line Input 6 will take priority in Zone 4 over all other Line Inputs, but not over the Facility Port.	OFF
J14	FOR FACTORY USE ONLY – DO NOT FIT A JUMPER HERE		
J15			
J16			
J17	Mic-over-Facility Port priority	OFF: The mic signals will be mixed at full level with both Facility Port inputs. ON: Signal at the mic inputs will cause inputs at either Facility Port to duck.	OFF
J18	Global Mic 1/Mic 2 Priority	OFF: Mic 1 and Mic 2 operate normally: inputs will be summed. ON: An signal at Mic Input 1 will cause Mic 2 input to be temporarily muted.	OFF
J19	Aux 1 source	Z1: Aux output 1 carries the same mic/music mix as Zone 1 Z3: Aux output 1 carries the same mic/music mix as Zone 3	Z1
J20	Aux 2 source	Z2: Aux output 2 carries the same mic/music mix as Zone 2 Z4: Aux output 2 carries the same mic/music mix as Zone 4	Z2
J21	Aux 1 level	TRACK: Aux output 1 level will be affected by the front panel MUSIC LEVEL control for Zone 1 or 3 (as selected by J19) FIXED: Aux output 1 source is derived pre the front panel MUSIC LEVEL control for Zone 1 or Zone 3 (as selected by J19)	TRACK

J22	Aux 2 level	TRACK: Aux output 2 level will be affected by the front panel MUSIC LEVEL control for Zone 2 or 4 (as selected by J20) FIXED: Aux output 2 source is derived pre the front panel MUSIC LEVEL control for Zone 2 or Zone 4 (as selected by J20)	TRACK
J23	Utility output music source	Z1: Music source for utility output follows Zone 1 music source selection. LINE1: Music source for utility output is always Line Input 1	Z1
J24	Utility output Mic-over-Music priority	OFF: Utility output is mix of Mic 1, Mic 2 and music, as set on rear panel ON: A signal at Mic 1 or 2 inputs will cause the music content of mix at the Utility output to temporarily duck	OFF
J25	Speaker 3 Routing	Z3: Speaker Output 3 will be fed by the pre-amplifier for Zone 3 Z1: Speaker Output 3 will be fed by the pre-amplifier for Zone 1	Z3
J26	Speaker 4 Routing	Z4: Speaker Output 4 will be fed by the pre-amplifier for Zone 4 Z2: Speaker Output 4 will be fed by the pre-amplifier for Zone 2	Z4

Troubleshooting

Fault conditions are indicated by the front panel **STATUS LED** **8** flashing either red or green.

Status LED flashes GREEN - Output Power reduced

If the temperature of a power stage exceeds 70°C the output power to that zone will be reduced linearly to maintain a safe operating temperature for the internal components. This feature prevents over-temperature shutdown from being triggered and is indicated by a flashing **GREEN STATUS LED**.

Status LED flashes RED - Over-temperature Shutdown

When the amplifier temperature exceeds 85°C, the unit will mute the speaker and auxiliary outputs: this state is indicated by a flashing **RED STATUS LED**. This fault will self-clear when the cause is removed or rectified, i.e., improve ventilation, reduce input signal level, etc.

Output power reduction or over-temperature shutdown can occur if the amplifier is incorrectly installed. In this event, investigate the following points:

- Incorrect output setting for connected speaker load.
- Elevated ambient temperature (> 40°C)
- Ventilation requirements not met (e.g., blocked air vents)
- Excessive signal input (**PEAK LED** illuminated constantly)

Status LED flashes RED - Amplifier output protection

The Series 46 mixer-amplifier incorporates the following protection schemes to prevent damage to the amplifier or connected speakers:

- Short Circuit protection
- Over-current protection
- DC protection

If any of the three protection schemes is triggered, the unit will mute the speaker and auxiliary outputs and flash the **STATUS LED RED**. The speaker wiring should be checked for faults. Power cycling is required to reset the mixer-amplifier if DC is detected at the output terminals; otherwise the fault state will self-clear when the output current reduces.

EMC Considerations

Cloud Series 46 mixer-amplifiers fully conform to the relevant electromagnetic compatibility (EMC) standards and are technically well behaved. You should experience no problems interfacing units to other items of equipment and under normal circumstances, no special precautions need to be taken.

If the unit is to be used in close proximity to potential sources of HF disturbance such as high power communication transmitters, radar stations and the like, it is suggested that input signal leads be kept as short as possible.

Always use balanced interconnections wherever possible. If the mixer-amplifier is mounted in a 19" rack, do not locate the unit in close proximity to a powerful amplifier of any kind, which may radiate a strong magnetic field from the power transformer.

Earthing

When several mains powered units are connected together via their signal cables, there is a risk of one or more earth loops which may cause an audible hum on the system even with the gain controls set to minimum.

The 0 V rail of a Series 46 mixer-amplifier is directly coupled to the chassis ground. No interconnection problems should be encountered, but if there is any hum or other extraneous noise when source equipment is connected, the situation can generally be remedied by observing the following guidelines:

- Always connect sources using balanced connections wherever possible, with the cable screen only connected at the receiving end (amplifier input).
- Use audio isolating transformers (readily available from trade suppliers) at the inputs if necessary. These will ensure that the amplifier is electrically isolated from the source equipment.
- The signal source units should be located as close as possible to the amplifiers and the metal housing of the various units should not be electrically connected together through the equipment rack. If this is a problem, rack isolating kits are available from specialist hardware suppliers. If the problem persists, try to connect all interconnected units, including power amplifiers to a common power source to ensure a common ground is provided.

TECHNICAL SPECIFICATIONS

Line Inputs				
Frequency Response	20 Hz to 20 kHz, ± 1 dB			
Sensitivity	195 mV (-12 dBu) to 2.0 V (+8 dBu)			
Input impedance	>10 kohms (balanced/unbalanced)			
Headroom	12 dB			
Noise	<-90 dB (22 kHz bandwidth)			
Equalisation	HF: ± 10 dB @ 10 kHz; LF: ± 10 dB @ 50 Hz			
Microphone Input				
Frequency Response	-3 dB @100 Hz (fixed filter) to 20 kHz, ± 1 dB			
Sensitivity	2.54 mV (-50dBu) to 245 mV (-10 dBu)			
Input Impedance	3.3 kohms (balanced)			
Phantom Power	12 V, switchable per-input by jumpers			
Headroom	16 dB			
Noise (EIN)	<-126 dBu			
Equalisation	HF: ± 10 dB @ 5 kHz; LF: ± 10 dB @ 100 Hz			
Facility Input				
Frequency Response	20 Hz to 20 kHz, ± 1 dB			
Sensitivity	0.775 V (0 dBu)			
Input impedance	10 kohms (balanced)			
Headroom	18 dB			
Noise Gate	-60 dB			
Main Output				
Output Power (1 kHz continuous sine wave)	46-120MK2	120 watts per zone nominal; 240 W total available in Power Sharing mode		
	46-240	240 watts per zone maximum		
Minimum load	Low-Z output	4 or 8 ohms		
	High-Z output	70 V-line	46-120MK2 46-240	41 ohms 20.5 ohms
		100 V-line	46-120MK2 46-240	66 ohms 33 ohms
	Frequency response	Low-Z output	20 Hz to 20 kHz, ± 1 dB	
High-Z output		20 Hz to 20 kHz, ± 1 dB (65 Hz filter off)		
THD + N	< 0.05% @ 1 kHz			
Protection	Fixed level signal limiter: DC, over-current and over-temperature protection. Internal and external 20 mm cartridge fuses.			
Utility and Auxiliary Outputs				
Nominal output level	0 dBu (0.775 V _{rms}), balanced			
Noise	<-90 dB, 22 kHz bandwidth			
General				
Power input	Universal type, 85 to 265 VAC, 45 to 65 Hz			
Fuse details	46-120MK2	5 x 20 mm, time delay, T5A		
	46-240	5 x 20 mm, time delay, T8A		
Normal operating temperature	0 °C to 35 °C (Note: performance and specifications cannot be guaranteed outside of this range)			
Cooling	Forced air cooling (front to back)			

Power consumption	Standby ¹	46-120MK2	9.35 W (29.33 VA)
		46-240	9.70 W (51.6 VA)
	Idle ²	46-120MK2	31.05 W (52.27 VA)
		46-240	35.20 W (72.58 VA)
	1/8 th Power ³	46-120MK2	105.7 W (124.65 VA)
		46-240	187.95 W (226.45 VA)
1/3 rd Power ⁴	46-120MK2	169.73 W (185.09 VA)	
	46-240	309.90 W (350.17 VA)	
Heat Loss	Standby ¹	46-120MK2	33.7 kJ/hr (31.9 BTU/hr)
		46-240	34.9 kJ/hr (33.1 BTU/hr)
	Idle ²	46-120MK2	111.8 kJ/hr (106.0 BTU/hr)
		46-240	126.7 kJ/hr (120.2 BTU/hr)
	1/8 th Power ³	46-120MK2	176.6 kJ/hr (167.5 BTU/hr)
		46-240	243.1 kJ/hr (230.5 BTU/hr)
1/3 rd Power ⁴	46-120MK2	219.2 kJ/hr (207.9 BTU/hr)	
	46-240	348.1 kJ/hr (330.1 BTU/hr)	
Dimensions (W x H x D)	Net	46-120MK2 and 46-240	482.6 mm x 88 mm (2U) x 407 mm 19" x 3.55" (2U) x 16.0" (less connectors & knobs)
	Shipping (Gross)		547 mm x 210 mm x 544 mm (21.5" x 8.3" x 21.4")
Weights	Net	46-120MK2	6.9 kg (15.46 lb)
		46-240	7.1 kg (15.9 lb)
	Shipping	46-120MK2	9.15 kg (20.5 lb)
		46-240	9.35 kg (20.9 lb)

Notes re Power Consumption and Heat Loss measurements:
All measurements at 230 VAC 50 Hz power input

1. Standby: amplifier in standby state (STATUS LED steady red)
2. Idle: amplifier not in standby state (STATUS LED steady green), but no audio output
3. 1/8th. Power: constant sound level at one-eighth maximum rated output (audio mainly clean, only occasional clipping)
4. 1/3rd. Power: constant sound level at one-third maximum rated output (audio beginning to become compressed, limited or heavily clipped)

cloud

www.cloud.co.uk

MADE IN BRITAIN 