

Rev. 1.2.0
Item no. OM-LUCIA

LUCIA®

Compact installation **amplifiers**



1. Important safety instructions

Before using your LUCIA Series amplifier, be sure to carefully read the applicable items of this Operation Manual and the Safety Instructions.

1. Read these instructions.
2. Keep these instructions
3. Heed all warnings.
4. Follow all instructions.
5. Do not use this apparatus near water.
6. Clean only with a dry cloth.
7. Do not block any ventilation openings. Install in accordance with the manufacturer's instructions.
8. Do not install near any heat sources such as radiators, heat registers, stoves, or other apparatus (including amplifiers) that produce heat.
9. Do not defeat the safety purpose of the polarized or grounding-type plug. A polarized plug has two blades with one wider than the other. A grounding-type plug has two blades and a third grounding prong. The wide blade or the third prong is provided for your safety. If the provided plug does not fit into your outlet, consult an electrician for replacement of the obsolete outlet.
10. Protect the power cord from being walked on or pinched, particularly at plugs, convenience receptacles, and the point where they exit from the apparatus.
11. Only use attachments/accessories specified by the manufacturer.
12. Use only with a cart, stand, tripod, bracket, or table specified by the manufacturer, or sold with the apparatus. When a cart is used, use caution when moving the cart/apparatus combination to avoid injury from tip-over.
13. Unplug this apparatus during lightning storms or when unused for long periods of time.
14. Refer all servicing to qualified service personnel. Servicing is required when the apparatus has been damaged in any way, such as power-supply cord or plug is damaged, liquid has been spilled or objects have fallen into the apparatus, the apparatus has been exposed to rain or moisture, does not operate normally, or has been dropped.



2. Approvals

This equipment has been tested and found to comply with the limits for a Class B Digital device, pursuant to part 15 of the FCC rules.

These limits are designed to provide reasonable protection against harmful interference in residential installations. This equipment generates, uses and can radiate radio frequency energy and, if not installed and used in accordance with the instructions, may cause harmful interference to radio communications. However, there is no guarantee that interference will not occur in a particular installation. If this equipment does cause harmful interference to radio or television reception, which can be determined by turning the equipment off and on, the user is encouraged to try to correct the interference by one or more of the following measures:

- Reorient or relocate the receiving antenna.
- Increase the separation between the equipment and receiver.
- Connect the equipment into an outlet on a circuit different from that to which the receiver is connected.
- Consult the dealer or an experienced radio/TV technician for help.

For customers in Canada

This Class B digital apparatus complies with Canadian ICES-003.

Cet appareil numérique de la classe B est conforme à la norme NMB003 du Canada.

3. Warnings

3.1 Explanation of warning symbols











The lightning bolt triangle is used to alert the user to the presence of un-insulated "dangerous voltages" within the unit's chassis that may be of sufficient magnitude to constitute a risk of electric shock to humans.



The exclamation point triangle is used to alert the user to presence of important operating and service instructions in the literature accompanying the product.

3.2 Warnings

-  To reduce risk of fire or electric shock, do not expose this apparatus to rain or moisture.
Français: Pour réduire les risques d'incendie ou de choc électrique, n'exposez pas l'appareil à la pluie ou à l'humidité.
-  Do not expose this system/apparatus to dripping or splashing and ensure that no objects filled with liquids, such as vases, are placed on the apparatus.
Français: N'exposez pas ce système/appareil au ruissellement ni aux éclaboussures et assurez-vous qu'aucun objet contenant du liquide tel qu'un vase n'est placé sur l'appareil.
-  This apparatus must be connected to a mains socket outlet with a protective earthing connection.
Français: Cet appareil doit être raccordé à une prise secteur avec terre de protection.
-  The mains plug is used as a disconnect device and shall remain readily operable.
Français: La fiche d'alimentation sert de dispositif de déconnexion et doit rester constamment accessible.
-  To prevent electric shock do not remove top or bottom covers. No user serviceable parts inside. Refer servicing to qualified service personnel.
Français: Pour prévenir un choc électrique, ne retirez pas les capots du dessus et du dessous. Aucune pièce n'est réparable par l'utilisateur à l'intérieur. Confiez toute réparation à un personnel de maintenance qualifié.
-  To completely disconnect this equipment from the AC mains, disconnect the power supply cord plug from the AC receptacle. The mains plug of the power supply cord shall remain readily operable.
Français: Pour totalement isoler l'équipement de l'alimentation secteur, débranchez le cordon d'alimentation de son embase. La fiche secteur du cordon d'alimentation doit rester accessible.
-  Do not install this device in a confined space.
Français: N'installez pas cet appareil dans un espace confiné.
-  Check the voltage in your area and use the correct type of mains connector.
Français: Vérifiez la tension en vigueur dans votre région et utilisez le bon type de fiche secteur.

Please refer to the following table:

Voltage	Line plug (according to standard)
110-125 V (US)	UL817 and CSA C22.2 no 42.
220-230 V (EUROPE)	CEE 7 page VII, SR section 107-2-D1/ IEC 83 page C4
240 V (UK)	BS 1363 of 1984. Specification for 13 A fused plugs and switched and unswitched socket outlets.

3.3 User responsibility

3.3.1 Mains connection grounding

Your amplifier must be connected to a grounded socket outlet.

3.3.2 Speaker output hazard

Power amplifiers are capable of producing hazardous output voltages. To avoid electrical shock, do not touch any exposed speaker wiring while the amplifier is operating. External wiring connected to the speaker terminals shall be installed by a qualified person, or ready-made leads or cords of appropriate capacity shall be used. As the amplifier outputs produce high voltage, do not connect or disconnect speaker cables when the mains power is on.

3.3.3 Radio interference

A sample of this product has been tested and complies with the limits for the European Electro Magnetic Compatibility (EMC) directive. It also has been tested and found to comply with the limits for a Class A digital device, pursuant to Part 15 of the FCC Rules. These limits are designed to provide reasonable protection against harmful interference from electrical equipment. This product uses radio frequency energy and, if not used or installed in accordance with these operating instructions, may cause interference to other equipment, such as radio receivers. However, there is no guarantee that interference will not occur in a particular installation. If this equipment causes harmful interference to radio or television reception (determined by turning the equipment on and off), the user may be able to correct the interference by one or more of the following measures:

- Check if the affected unit complies with the EMC limits for immunity, (CE-labeled). If not, address the problem with the manufacturer or supplier. All electrical products sold in the EC must be approved for immunity against electromagnetic fields, high voltage flashes, and radio interference.
- Consult the dealer or an experienced radio/TV technician for help.
- Reorient or relocate the antenna.
- Increase the separation between the equipment and receiver.
- Connect the equipment into an outlet on a circuit different from that to which the receiver is connected.

3.3.4 Speaker damage

Many loudspeakers can be easily damaged or destroyed by overpowering them. Always check the speaker's continuous and peak power capabilities. The low impedance Lucia models have the ability to set output power limitation, allowing Lucia output power to be adjusted to ensure that it does not exceed loudspeaker specifications.

3.3.5 Maintenance

For safe and reliable operation, any dust collected in the front panel should be removed regularly. In rare circumstances, accumulated dust could ignite due to high internal temperatures and cause a fire. If the front is clogged so that air cannot pass, then the unit will eventually go into thermal protection; any resultant problems will not be covered by the warranty.

4. Table of Contents

- 1. Important safety instructions.....2**
- 2. Approvals.....2**
- 3. Warnings.....2**
 - 3.1 Explanation of warning symbols.....2
 - 3.2 Warnings3
 - 3.3 User responsibility.....3
- 5. Introduction6**
 - 5.1. Welcome6
 - 5.2. Features (all LUCIA models)6
 - 5.3. Additional features on LUCIA 120/2M and 240/2M only6
 - 5.4. Additional features on LUCIA 60/2, 120/2 and 240/2 only.....7
 - 5.5. Additional features on LUCIA 60/1-70, 120/1-70 and 240/1-70 only.....7
- 6. Unpacking and visual checks7**
- 7. Installation7**
 - 7.1. Wall mounting7
 - 7.2. Rack shelf mounting7
 - 7.3. Lab.gruppen rack shelf kit7
- 8. Cooling and fan operation8**
- 9. Operating voltage8**
- 10. Grounding8**
- 11. Front panel9**
- 12. Rear panel10**
- 13. Set-up and operation12**
 - 13.1. Auto standby / Power-up12
 - 13.2. GPIO configuration12
 - 13.3. GPIO Configuration: Mono high-impedance models.....13
 - 13.4. Protection mode14

14. LUCIA application browser	14
14.1. Introduction	14
14.2. Software download and installation	14
14.3. Overview	15
14.4. Factory presets	15
14.5. Application presets: Selection and custom configuration	16
14.5.1. Configuration in application view	16
14.5.2 Configuration in block diagram view	16
14.5.2.1. Input block	17
14.5.2.2. Matrix block	17
14.5.2.3. Output block	18
14.5.2.4. Control block	19
14.6. Saving and storing custom applications	20
14.6.1. Saving applications	20
14.6.2. Storing and sharing applications	20
14.7. Programming a LUCIA device	20
14.8. Online mode	21
14.9. Upgrading the firmware in a LUCIA device	21
15. Appendices	22
15.1. Default configuration for LUCIA base models	22
15.2. Default configuration for LUCIA M models	22
15.3. Default configuration for LUCIA 70V models	22
15.4. External control via GPI: Connection and components	22
15.5. Thermal dissipation	24
15.6. Technical Specifications	29
16. FAQ	32

5. Introduction

5.1. Welcome

Thank you for purchasing a Lab.gruppen LUCIA compact installation amplifier. We are confident it will provide outstanding performance, reliable operation and a long service life in any type of commercial sound or general AV application.

Lab.gruppen's innovative LUCIA (Localized Utility Compact Intelligent Amplification) brings superior audio performance and extraordinary flexibility to a decentralized approach in AV systems design. Power, processing, control and I/O are conveniently placed exactly where they are needed. In many AV applications requiring consistent, high quality audio output, LUCIA offers a logical, cost-efficient and scalable solution that eliminates the complications and added expense of a centralized equipment room for amplification, matrixing and processing. All LUCIA amplifiers incorporate a digital, firmware-controlled front end coupled to a robust, durable and highly efficient Lab.gruppen output stage, all of which make it the best sounding compact amplifier in its category.

LUCIA amplifiers install quickly and easily, with the supplied wall-mount bracket enabling discreet on-wall placement behind video displays. All connections are via Euroblock screw terminals, and level setting is available on front-panel potentiometers. An advanced protection scheme protects the amplifier and connected loudspeakers from potential damage caused by clipping, thermal overload, or extreme low line voltage.

5.2. Features (all LUCIA models)

- **Comprehensive DSP features** – Per channel presets for high-pass filter, parametric EQ, multi-band compressor, and look-ahead limiter
- **Automatic Dynamic Loudness Contouring™** – DSP automatically adapts to optimize performance at any output level
- **Optimized presets** – Available for specific loudspeaker models
- **Configuration software** – Windows and Mac software wizard for initial set-up, and advanced editor for preset configuration (LUCIA connection via USB)
- **RS232** – Remote control and monitoring from third party control solutions
- **GPIO** – Remote control (e.g. wall panel) for channel switching, level control and integration with paging systems
- **Efficient Class D amplifier** – Patented design for low distortion and minimal heat dissipation
- **Compact form factor** – Half-rack, 1U chassis and supplied bracket for discreet on-wall mounting (e.g. behind display screens)
- **Intelligent fan control** – Silent operation at idle and at lower output levels
- **Fail-safe operation** – Comprehensive short circuit, thermal, and under-voltage protection
- **Universal power supply** – Operates at 100 - 240 V AC (50 or 60 Hz)
- **ENERGY STAR® qualified** – Conforms to latest specification energy efficiency standards

5.3. Additional features on LUCIA 60/2M, 120/2M and 240/2M only

- **Maximum output power across range of loads** – Power output remains constant into 2, 4 or 8 ohms
- **Auto Load Sense™** – Proprietary auto-set VPL™ (Voltage Peak Limiter) for optimum performance with any connected load
- **4 x 4 mix matrix** – Route input signals internally to amplifier or to line-level outputs

5.4. Additional features on LUCIA 60/2, 120/2 and 240/2 only

- **Maximum output power across range of loads** – Power output remains constant into 2, 4 or 8 ohms
- **Auto Load Sense™** – Proprietary auto-set VPL™ (Voltage Peak Limiter) for optimum performance with any connected load
- **2 x 2 mix matrix** – Route input signals internally to either one or both amplifier channels

5.5. Additional features on LUCIA 60/1-70, 120/1-70 and 240/1-70 only

- **Model for constant voltage applications** – into 70 V/100 V
- **2 x 1 mix matrix** – Mix two sources to mono or use for source selection

6. Unpacking and visual checks

Every Lab.gruppen amplifier is carefully tested and inspected before leaving the factory and should arrive in perfect condition. If any damage is discovered, please notify the shipping carrier immediately. Save the packing materials for the carrier's inspection and for any future shipping.

7. Installation

7.1. Wall mounting

For attaching brackets (marked "B" on the drilling guide; see inside the shipping box) to the wall, please use appropriate means for mounting to a specified load of 3 kg minimum on each screw. Ensure that all four screws are secured properly to the wall. For drywall mounting, use a woodscrew (3.5 mm diameter with 25 mm minimum length) and 4.5 mm drywall plug with specified maximum load of greater than 3 kg (e.g. Molly E22412). This method of mounting is evaluated for North America according to UL/CA60065.

For mounting on surfaces other than drywall, please ensure that the method of mounting is suitable for the wall material. Also, be certain that the brackets are secured to the wall with the appropriate means to ensure similar load condition as specified previously. To attach the wall brackets "B" to your amplifier, please use the supplied 3 mm Torx machine screws.

7.2. Rack shelf mounting

The amplifier can be mounted to a rack shelf or similar by means of the three holes in the bottom marked "A" on the drilling guide (see inside the shipping box). Use a 4 mm diameter machine screw (not supplied), ensuring that the length of the screw is suitable for the thickness of the shelf. The screws used should not penetrate into the amplifier for more than 10-20 mm after mounting.

7.3. Lab.gruppen rack shelf kit

A special dedicated rack mount shelf designed to hold two LUCIA amplifiers is available from Lab.gruppen as an accessory. It includes all necessary accessories, screws, and mounting instructions.

8. Cooling and fan operation

Ensure that there is sufficient open space on at least two ventilating surfaces (top, bottom, front and rear) of the amplifiers to allow for free air flow. Please refer to the Thermal Dissipation Chart (Section 15.4) when installing large numbers of amplifiers in air conditioned spaces.

LUCIA amplifiers feature intelligent fan control as shown in the following table.

Fan mode description	Sustainable average output power	Loudspeaker SPL extra rel. 1 W sensitivity*	Distance at which you get the 1 W SPL**	Fan noise at 1 m distance
Low SPL applications with proper ventilation (meeting rooms, etc.)	Up to 2x 6 W	7.8 dB	2.5 m	Off
Medium SPL applications – whisper mode	Up to 2x 12 W	10.8 dB	3.5 m	<< 32 dBA
Maximum SPL with 120/2	2x 22 W	13.4 dB	4.7 m	33 dBA
Maximum SPL with 240/2	2x 44 W	16.2 dB	6.7 m	36 dBA

Table interpretation: In a typical application, if a loudspeaker has a sensitivity of 87 dB SPL at 1 m for 1 W, then the fan will stay silent for SPL levels up to ~95 dB (87 + 7.8) at 1 m distance from the loudspeaker; at 2.5 m from the loudspeaker will maintain levels up to 87 dB with the fan off. If the sustained average output is higher, the fan starts in whisper mode; however, this shouldn't be an issue as the program SPL is so much higher, likely above 80 dB no matter where you are in the room.

9. Operating voltage

LUCIA amplifiers have a universal power supply that operates on AC mains from 100 – 240 V at 50 or 60 Hz. The power receptacle on the rear panel accepts the supplied IEC cord which terminates in a connector appropriate for the country of sale.

10. Grounding

Signal ground is floating via a resistor to chassis, and therefore grounding (earthing) is automatic. For safety reasons, never disconnect the earth (ground) pin on the AC power cord. Use balanced input connections to avoid hum and interference when longer input cables (more than about 1 m/ 39") are used.

11. Front panel

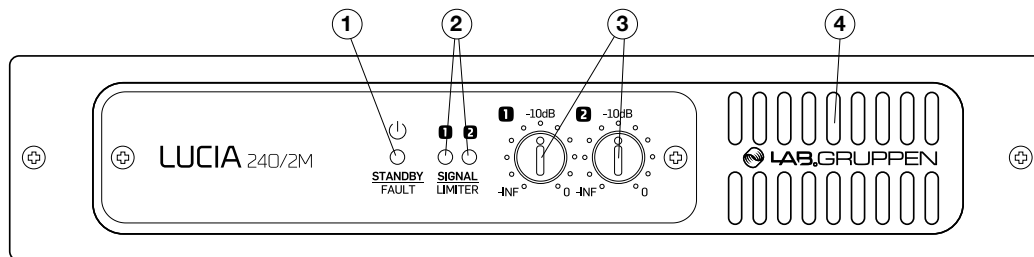

The front panel presents the following amplifier status indicators:

1 Standby/On LED indicator – A three-color LED illuminates amber when amplifier is in standby power mode and illuminates green when the amplifier is on. When the amplifier enters Protection Mode, the LED flashes red and the speaker outputs are muted. See “Protection mode” in Section 13.3.

2 Signal present/limit/clip indicators – A three-color LED illuminates to provide channel status information as follows:

Green – Signal is present at the input and the channel is operating normally.

Amber – Limiting is active on the channel. Limiting is engaged when:

- The channel reaches the voltage limit as determined by the automatic Voltage Peak Limiter (VPL) setting
- Maximum current output is reached
- Mains voltage cannot maintain rail voltage

Red – Channel is clipping either at the input or in DSP

3 Signal attenuators – A signal attenuator is provided for input channels 1 and 2. Attenuators are adjustable over a range of – infinity to 0 dB.

Note: In LUCIA constant voltage mono models (60/1-70, 120/1-70 and 240/1-70), the attenuators act as an input select and mixer by adjusting each input level that goes to the single output channel.

4 Airflow input – Make certain this input is not blocked or covered.

12. Rear panel

12.1. Two output low impedance models: (LUCIA 60/2, 120/2, 240/2, 60/2M, 120/2M, 240/2M)

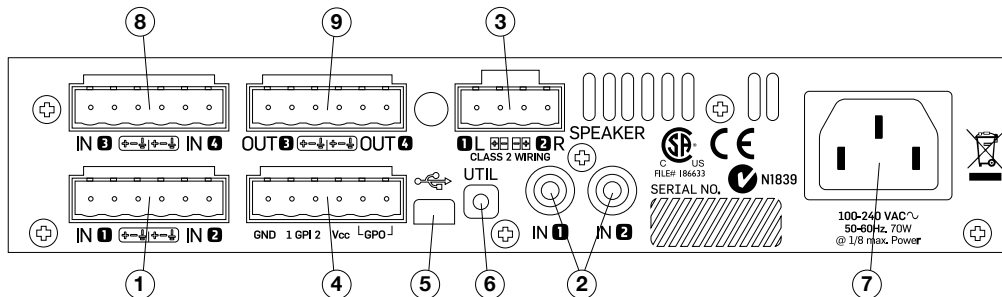

1 Balanced audio inputs (1 & 2) – Connect balanced inputs using 3-pole Euroblock connectors. Correct polarity (+, -) and ground terminations are shown on the rear panel. Observe polarity to avoid low frequency cancellation loss, especially if mixing to mono in in the matrix.

2 Unbalanced audio inputs (1 & 2) – Connect unbalanced inputs (e.g. local video screen output, CD player) to the RCA (cinch/phono) inputs. Balanced and unbalanced inputs feed an internal analog mixer with optimized gain settings to ensure that full level can be reached no matter which input is used. A balanced and an unbalanced input can be connected simultaneously and “the choice of input” is determined by which device is currently playing.

3 Speaker outputs – Connect loudspeakers with nominal impedance of 2, 4, 8 or 16 ohms. Maximum connector current rating is 41 Arms (exceeding capacity of the amplifier). Cables up to 4 mm² (12 AWG) can be accommodated. Observe polarity to avoid low frequency cancellation loss.
Note: Bridge mode connection is not supported.

4 GPIO/Remote connector – Connect external control and status monitoring devices using the six-pole Euroblock connector. See “GPIO Configuration” in Section 13.2.

5 USB port – Connects to external computer for downloading DSP presets. See “Programming a LUCIA Device” in Section 14.7. Connection requires cable with a Mini B type connector (included).

6 UTIL (Utility) switch – Recessed switch places unit in update mode for firmware updates. Insert the USB connector and then push and hold the switch to activate update mode. A red light on the back plate will indicate that the unit is in update mode.

7 AC line input – Connect the included IEC power cable.

The following features are located on the rear panel of LUCIA 60/2M, 120/2M and 240/2M only:

8 Balanced audio inputs (3 & 4) – Connect balanced inputs using 3-pole Euroblock connectors. Correct polarity (+, -) and ground terminations are shown on the rear panel.

9 Matrix line outputs – Connect balanced line output cable using 3-pole Euroblock connectors. Correct polarity (+, -) and ground terminations are shown on the rear panel.

12.2. Mono high-impedance models: (LUCIA 60/1-70, 120/1-70, 240/1-70)

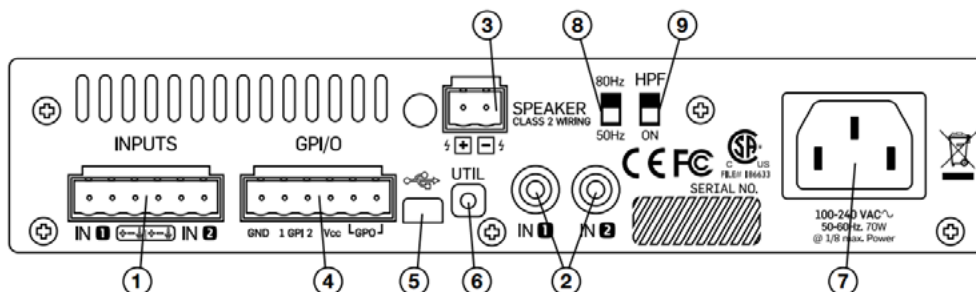

1 Balanced audio inputs (1 & 2) – Connect balanced inputs using 3-pole Euroblock connectors. Correct polarity (+, -) and ground terminations are shown on the rear panel.

2 Unbalanced audio inputs (1 & 2) – Connect unbalanced inputs (e.g. local video screen output, CD player) to the RCA (phono) inputs. Note: Balanced and unbalanced inputs are in parallel; only one pair of inputs should be connected at one time.

3 Speaker outputs – Connect to loudspeakers in a 70 V or 100 V distributed system. Note that if the transformer has marking for 100 V, then the same total power will be delivered as with 70 V. However, since limiting engages at -3 dB relative to 100 V, the power delivered per loudspeaker will be half of the marking on the loudspeaker transformer. Consequently, taps should be set to twice the desired power.

4 GPIO/Remote connector – Connect external control and status monitoring devices using the six-pole Euroblock connector. See “GPIO Configuration” in Set-up and Operation section following.

5 USB port – Connects to external computer for downloading DSP presets. Connection requires cable with a Mini B type connector (included).

6 UTIL (Utility) switch – Recessed switch places unit in update mode for firmware updates. The switch must be pushed in and held down while the USB connector is being inserted to activate update mode.

7 AC line input – Connect the included IEC power cable.

8 High pass frequency – Select 80 Hz or 50 Hz for high pass cutoff frequency. This filter is in series with what gets configured in the Application Browser software.

9 HPF switch – Select ON or bypass for the high pass filter

13. Set-up and operation

13.1. Auto standby / Power-up

LUCIA amplifiers do not have a power switch. The amplifier will turn on automatically when AC power is connected to the unit; it will go into standby mode if no signal is present at any input for 20 minutes. When in standby, the amplifier will power up in 0.9 seconds when a signal above the preset threshold (-54 dBu) is present at any channel input.

In order to avoid issues with the signal being too low relative the threshold it is generally better to use full level from the source and to reduce the gain in the LUCIA instead using the front controls, GPI or in the matrix.

13.2. GPIO configuration: Two output impedance models

All low impedance LUCIA models provide the default functionality described below for General Purpose Inputs and Output (GPIO).

Remote volume control – The default functionality for the GPI is independent control of output volume (output 1 on GPI1 and output 2 on GPI2). Please note that this control is in series with the control on the front panel. There are two ways to do this:

- A.** Connect a GPO from an external control device with a control voltage output of 0 – 3.3 V. The ground of the control device must be connected to the ground pin of the LUCIA GPIO connector.
- B.** Connect a remote volume control potentiometer per channel to pins 1 through 4 of the GPIO connector as shown below. (The VCC voltage output is 3.3 V). If you want the link the control, then you simply link GPI1 and GPI2 together with a jumper cable.

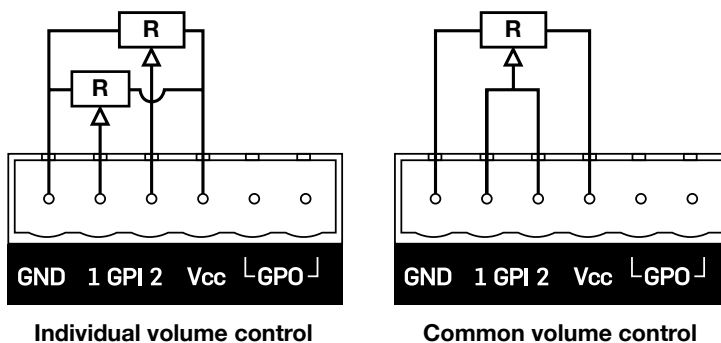

Amplifier status – Pins 5 and 6 connect to an internal relay to provide amplifier fault indication. The relay is closed when the amplifier is on and operating normally. The relay opens if a fault in either channel or in the power supply interrupts normal operation of one or both channels.

Optional GPIO modes – The LUCIA models allow other GPIO functions to be enabled by applying changes to the amplifier firmware. See “Control Block” in Section 14.5.2.4.

13.3. GPIO Configuration: Mono high-impedance models

The Default functionality is as described below for General Purpose Inputs and Output (GPIO).

Remote volume control – Connect a remote volume control potentiometer to Ground, GPI1 and Vcc as shown in the diagram following. Volume control is after input mixing. (The Vcc voltage output is 3.3 V).

Amplifier wake-up – Connect an external contact closure to Ground and GPI2 as shown in the diagram following. Wake-up happens within 0.5 s after contact closure.

Amplifier status – Pins 5 and 6 connect to an internal relay to provide amplifier fault indication. The relay is closed when the amplifier is on and operating normally. The relay opens if a fault in either channel or in the power supply interrupts normal operation of one or both channels.

Optional GPIO modes – The LUCIA models allow other GPIO functions to be enabled by applying changes to the amplifier firmware. See “Control block” in Section 14.5.2.4.

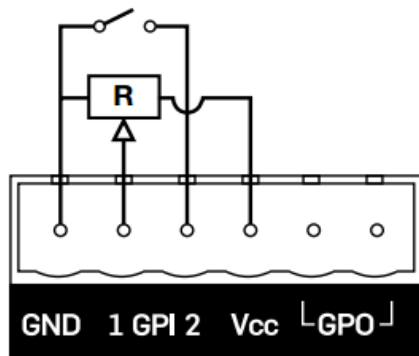

13.4. Protection mode

The amplifier enters Protection mode when thermal conditions or current draw exceed safe limits. When the amplifier cools below the thermal threshold, or nominal load conditions are restored, the amplifier exits Protection mode automatically.

IMPORTANT – Protection mode often results from excessive operating levels, improper load conditions or insufficient ventilation. Always check these conditions any time a LUCIA amplifier enters Protection mode.

14. LUCIA application browser

14.1. Introduction

The LUCIA Application Browser is a simple, intuitive software editor for configuring the signal matrixing and DSP features. Amplifier functions are quickly programmed offline and then downloaded to the individual LUCIA units via the USB port.



Note: Factory presets for common applications include input and matrix settings plus output equalization pre-optimized for compatible Tannoy loudspeakers and generic loudspeaker types. All parameters are user adjustable, allowing creation of custom user presets that may be stored for future use. An online “sync mode” allows real-time setting of parameters – a useful feature for adjusting loudspeaker response for room acoustics using the four-band parametric equalizers.

14.2. Software download and installation

The LUCIA Application Browser software is available for free download from the Support section of the Lab.gruppen web site. Select Software & Firmware from the left-hand menu. You must be registered to access the download pages.

Under LUCIA, select LUCIA Application Browser. Follow the on-screen instructions. Note that there is no separate installation wizard. When downloading the compressed (zipped) file, simply save to any convenient location (desktop, documents) where write privileges are available.

14.3. Overview

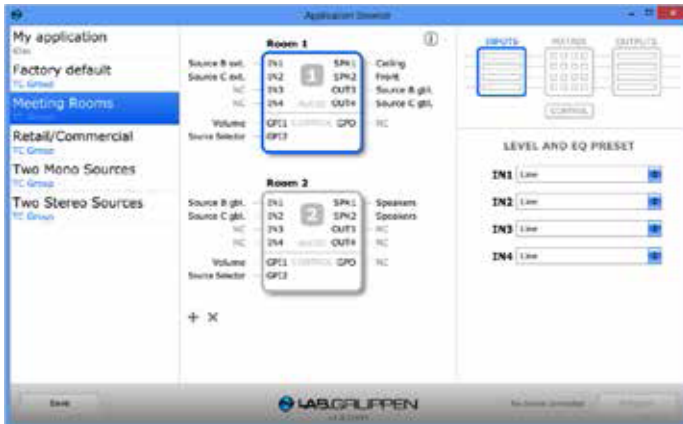

The LUCIA Application Browser opens to a single main window. All device configuration is accomplished using this one view. The window is divided into three columns:

Application Selector column – The left-hand column lists all application presets currently available for downloading to LUCIA devices. When created, new user presets are added at the top of the list.

Application View column – The center column shows a graphical representation of the device(s) in the application preset and the current configuration of inputs, outputs and GPIO together with the option to fetch current settings from connected LUCIA and enable password protection on settings applied. Multiple LUCIA devices may be included in a single preset. If more than one device is shown, the device currently selected for parameter configuration of downloading of a preset will be shown with a blue frame.

Block Diagram column – The right-hand column displays the various options and tools available for configuring the device. Four icons are displayed in a block diagram format: Inputs, Matrix, Outputs and Control. When an icon is selected, the applicable configuration tools appear in the column below.

14.4. Factory presets

All factory presets are displayed in the Application Selector column. The number of factory presets available will depend on the version of software installed, as new presets will be added to later versions. Factory presets are developed by TC Group product specialists to provide quick set-up and optimum performance in a variety of common AV installations. New users are advised to review all available factory presets to determine which one is closest to the requirements of a specific installation. This will minimize the amount of time required to create a custom user preset.

Note: Clicking on the “i” icon at the top of the column opens an information window with a description of the currently selected preset application. Descriptions also may be added when creating custom user presets.

14.5. Application presets: Selection and custom configuration

14.5.1. Configuration in application view

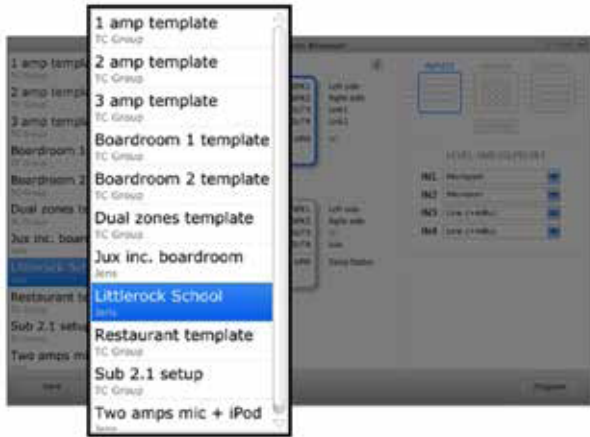

Select the factory application or existing user application that is closest to the requirements of the new application.

If necessary, add one or more additional devices to the application. Parameter presets for multiple units can be saved as one application file. Click the “+” at the bottom of the column to add another device to the application. Note that saving multiple units as one Application is for user convenience only; parameters for each device must be downloaded separately.

Select a device for editing. The selected device shows a blue frame.

Name Inputs, Outputs and GPIO connections. Click on the existing name to edit the text.

Using the small “arrow” beside the selected device, it is possible to get settings from the connected LUCIA. This action can only be performed if the selected configuration model is identical to the connected LUCIA.

By enabling the small “lock” beside the selected device, it is possible to apply a password to protect settings applied to the connected LUCIA, preventing unauthorized users obtaining knowledge of system configuration.

Note: The password protection only applies when a user tries to get settings from a password protected LUCIA. So, users are always able to apply new settings to overwrite password protected settings if desired.

14.5.2 Configuration in block diagram view

When a device is selected, the corresponding Application parameters are shown in the Block Diagram view in the right-hand column. Click on the Input Block, Matrix Block, Output Block or Control Block to edit parameters.

14.5.2.1. Input block

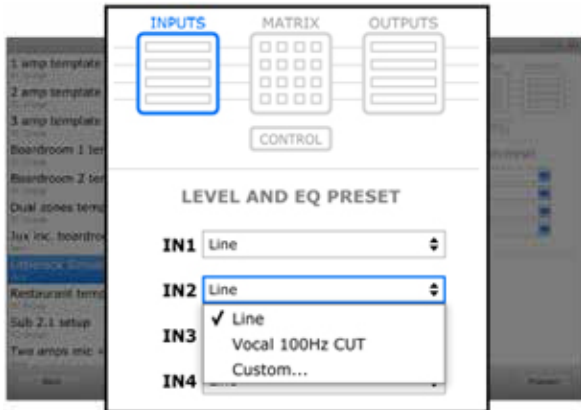

Each of the four inputs offers an option for either flat response (Line) or insertion of a low-cut filter optimized for speech input (Vocal 100 Hz CUT). A third option (Custom...) allows user configuration of the 4 EQ sections on each input. **Select the option appropriate for your application.**

14.5.2.2. Matrix block

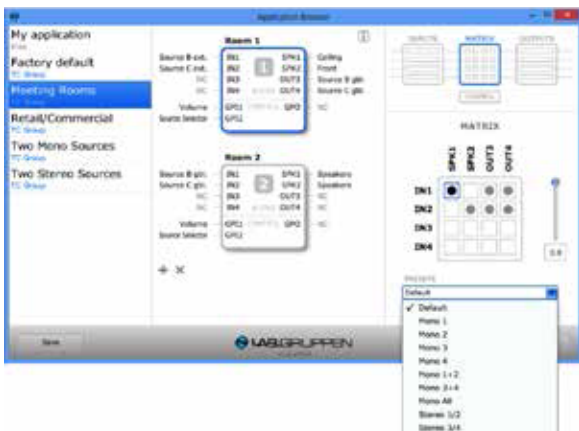

The Matrix feature allows any of the inputs to be routed to any output. The level for each matrix route is adjustable from 0 to -30 dB using the fader to the right of the matrix.

Manual routing – Click in the box to select the desired input-to-output routing.

Preset routing – Matrix settings appropriate for many applications are available as presets using the scroll-down menu under Presets below the Matrix box.

Level setting – Select the desired matrix route (framed in blue) and use the fader to set the level.

Note: The Matrix selection function is disabled when a GPI function is assigned as Source Selector. (See Section 14.5.2.4). This prevents possible confusion and errors.

14.5.2.3. Output block

In the Outputs section you can configure the output processing of individual channels for optimal response from the connected loudspeakers.

Factory presets – Presets are provided with output equalization optimized for many Tannoy loudspeakers. Additional presets are provided for generic full-range loudspeakers, with each offering a selection of low-cut filters.

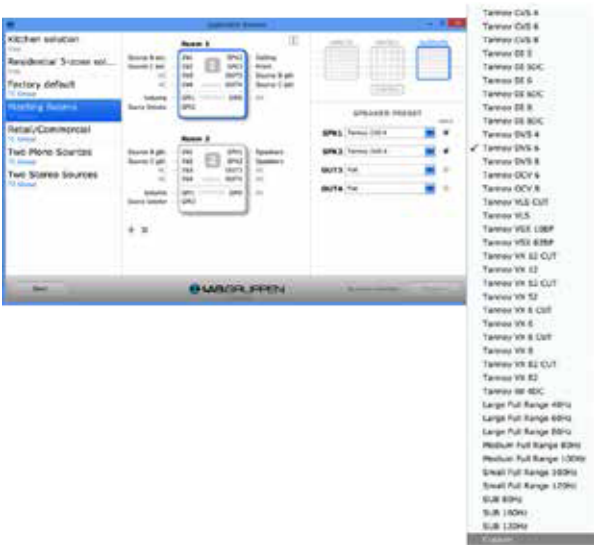

Custom user presets – To create a custom Output preset, scroll to the bottom of the menu and select Custom. A pop-up window gives access to the output filters that may be customized by the user. For each of the four filter sections you can select filter type by clicking on the icon. The available filter types are:

- Low Cut 12
- Low Cut 6
- Low Shelf 12
- Low Shelf 9
- Low Shelf 6
- Low Shelf 3
- Band
- High Shelf 3
- High Shelf 6
- High Shelf 9
- High Shelf 12
- High Cut 6
- High Cut 12

- Low Cut 12* (second order 12 dB per octave high pass Butterworth filter)
- Low Cut 6 (first order 6 dB per octave high pass Butterworth filter)
- Low Shelf 12 (Shelving boost or cut with 12 dB per octave slope)
- Low Shelf 9 (Shelving boost or cut with 9 dB per octave slope)
- Low Shelf 6 (Shelving boost or cut with 6 dB per octave slope)
- Low Shelf 3 (Shelving boost or cut with 3 dB per octave slope)
- Band** (normal **parametric EQ** for which the width is defined in octaves)
- High Shelf 3 (Shelving boost or cut with 3 dB per octave slope)
- High Shelf 6 (Shelving boost or cut with 6 dB per octave slope)
- High Shelf 9 (Shelving boost or cut with 9 dB per octave slope)
- High Shelf 12 (Shelving boost or cut with 12 dB per octave slope)
- High Cut 6 (first order 6 dB per octave low pass Butterworth filter)
- High Cut 12* (second order 12 dB per octave low pass Butterworth filter)

*: If you wish to implement a 24 dB per octave high or low pass Linkwitz-Riley filter, then simply select two 12 dB filters and set them to the same frequency.

Edit the output filters by (as appropriate) selecting an alternative filter type and entering new values in the parameter boxes. (Only those parameters applicable to the filter type will be accessible.)

To save the custom filter, click on OK. To exit without saving changes, click CANCEL.

ADLC (Automatic Dynamic Loudness Contouring) – ADLC is a sophisticated, DSP-controlled function that maintains optimum sound balance regardless of listening level. ADLC may be enabled or disabled using the radio buttons to the right of each speaker preset.

Adjustable delay – It is possible to add a delay (0-120 ms) to the overall latency on each output.

Adjustable power output – The low impedance LUCIA models enable the option to adjust maximal output power on each output channel by limiting the maximal peak voltage (Vpk).

14.5.2.4. Control block

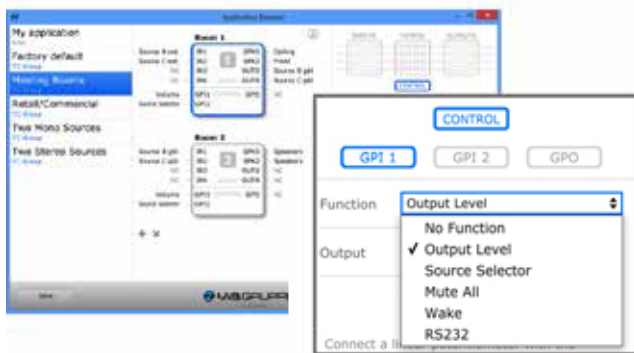

The Control Block allows the user to define functions for each of the two GPI ports of the device by selecting a function from the MODE menu. The functions available for each port are:

- Output Level
- Source Selector
- Mute All
- Wake
- RS232
- No Function (disabled)

When Wake or Mute functions are selected in MODE, the PRESET box shows a description of the function. These are described as Open/Close referring to that the only thing needed is a switch connected between GND and the GPI pin. So, in this scenario Close means that the GPI gets a voltage very close to zero (GND) and Open means that the voltage is close to Vcc (thanks to an internal connection).

When RS232 is selected, it is possible for third-party products to remote control and monitor LUCIA via RS232 serial interface. For more information on RS232 serial interface usage, please refer to the “LUCIA Serial Dongle – RS232 Quick Start Guide”, which can be downloaded from <http://labgruppen.com/support/download-quick-start-guide>

When Source Selector or Output Level functions are selected, available options are shown in the PRESET box.

The GPO is not reconfigurable; the Control Block shows current functionality.

14.6. Saving and storing custom applications

14.6.1. Saving applications

Once you have completed configuration of a custom Application, click on the Save button. A dialog window will open which allow you to enter a file name, author and a description of the Application preset. Click on the Save button in the dialog window to save the Application file.

The new custom Application will appear at the top of the list in the left-hand column.

NOTE: If you click on another Application from the left-hand application menu before saving the file, a prompt will appear asking if you wish to save the file.

IMPORTANT: Do not close the main Application Browser window (quit the program) before saving an Application file. The window will close immediately with no prompt, and all entered information will be lost.

14.6.2. Storing and sharing applications

Regardless of the location of the Application Browser (desktop, documents etc.), all Application files will be stored at C:\Users\username\Documents\LUCIA Applications. Application files may be shared by copying to or from this folder.

14.7. Programming a LUCIA device

To program a LUCIA device, first select the desired application from the list in the left-hand column. If the Application includes more than one device, select the desired device. It will show with a blue frame.

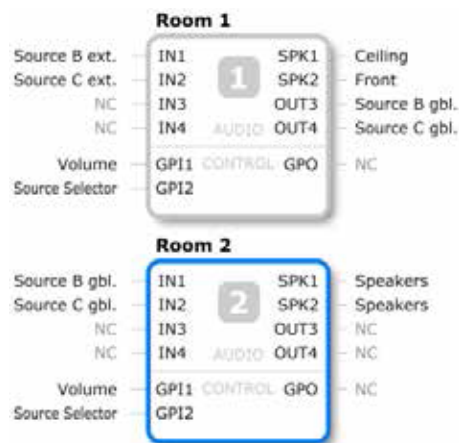

Connect a USB cable from the computer to the LUCIA device. The PROGRAM button will show as enabled as soon as the connection is established.

Press the Program button

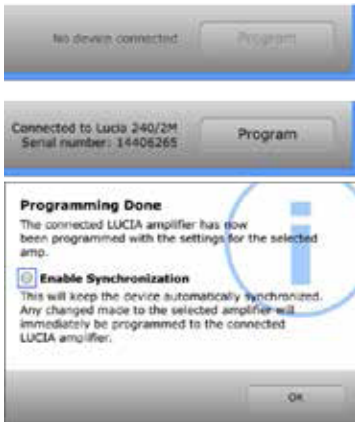

A confirmation dialog will show when the settings have been successfully transferred to the device. The dialog also shows an option to Enable Synchronization. If you want to further edit parameters in real time, click the button and then click “OK.” (See Online Mode following.) If you do not want to do real-time edits, simply click “OK.”

14.8. Online mode

To enter Online Mode, click the “Enable Synchronization” button when programming a LUCIA device. (See Section 14.7.)

A device connected in Online Mode shows in the Application Browser with an orange frame.

In Online Mode, any changes made to parameters in the Application Browser are transferred in real time to the connected LUCIA device. A circular animation shows in the selected device while updating is in progress. Online Mode is particularly helpful for adjusting output equalization while listening to or measuring the connected loudspeaker(s).

To exit Online Mode, press the “Sync Enabled” button or select another device.

14.9. Upgrading the firmware in a LUCIA device

As features are added, the firmware in the LUCIA will eventually require upgrading. While the LUCIA is connected to the host computer, the Application Browser will check that the firmware version will support the selected application before the application is programmed to the device. If an upgrade is required, then a wizard will guide you through the upgrade procedure with step-by-step instructions. Each step will be verified by the wizard to keep this procedure simple and secure.

In the unlikely event that it should fail to update, restart the Application Browser and see what it says; if required - put the LUCIA in update mode and try again.

15. Appendices

15.1. Default configuration for LUCIA base models

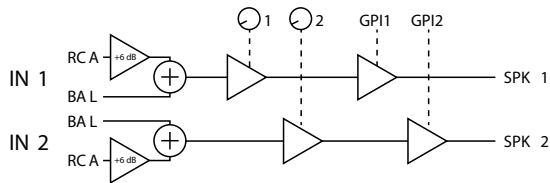

15.2. Default configuration for LUCIA M models

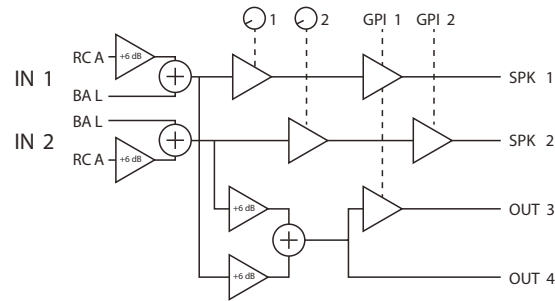

15.3. Default configuration for LUCIA 70V models

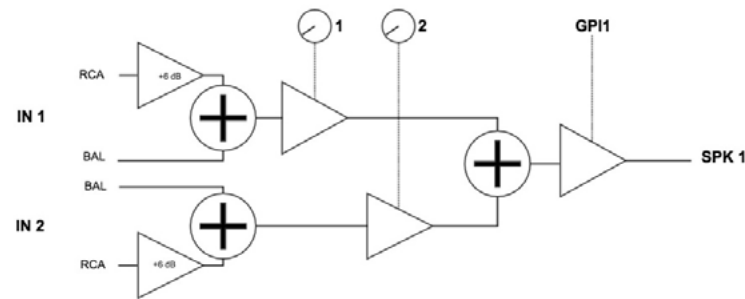

15.4. External control via GPI: Connection and components

The default function for GPI is level control, a linear potentiometer with a value between 1 k to 100 k ohm can be used. As the GPI is internally pulled high it will default to full level if no potentiometer is connected. If the cable is a shielded twisted pair, then the shield should be connected to ground. Alternately 3 tightly twisted leads can be used. The potentiometer should be connected so that the wiper (the sliding contact) is at the Vcc side of the potentiometer for maximum level and at the GND side for Mute.

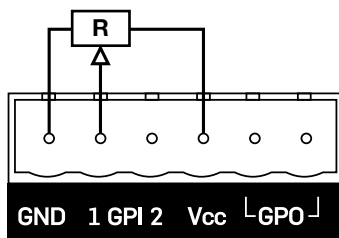

A resistor ladder selector can be used to perform selection of up to 4 different alternatives. The total impedance should be between 1k and 100k ohm and one way to do it is as illustrated below (this is also how the Lab.gruppen accessory is made). Selection and voltages for each of the selected positions is fully configurable.

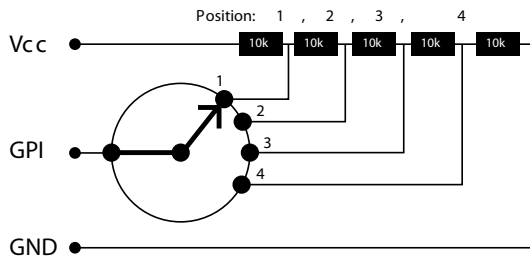

For functions like push to talk and mute all a simple contact closure can be used with LUCIA M. It should be connected between ground and GPI.

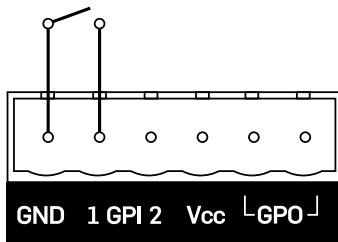

15.5. Thermal dissipation

LUCIA 60/2										
Level	Load	Output power		Mains		Watt *1)			Thermal Dissipation	
				VAC	IAC	In	Out	Dissipated	BTU/hr	kCal/hr
Standby w. remote Power Off.				230	0,032	0,88	0	1	3	1
				120	0,027	0,77	0	1	3	1
				100	0,028	0,76	0	1	3	1
Power On, Idling				230	0,12	11,9	0	12	41	10
				120	0,19	13,0	0	13	44	11
				100	0,22	13,1	0	13	45	11
Pink pseudo noise (1/8)	16 Ω / Ch.	15	x 2	230	0,16	18,6	3,8	15	51	13
				120	0,26	18,6	3,8	15	51	13
				100	0,30	18,8	3,8	15	51	13
	8 Ω / Ch.	30	x 2	230	0,20	23,8	7,5	16	55	14
				120	0,32	23,3	7,5	16	54	14
				100	0,37	23,7	7,5	16	55	14
	4 Ω / Ch.	30	x 2	230	0,20	24,1	7,5	17	57	14
				120	0,33	23,9	7,5	16	56	14
				100	0,37	24,2	7,5	17	57	14
	2 Ω / Ch.	30	x 2	230	0,21	24,8	7,5	17	59	15
				120	0,34	24,6	7,5	17	58	15
				100	0,39	24,8	7,5	17	59	15

*1) The amplifier's PSU operates as a non-resistive load, so the calculation "Volts x Amps = Watts" would not be correct. Instead, measured and specified here is what is known as the "Active Power" in the amplifier providing useful, real-world values of power consumption and heat dissipation.

LUCIA 60/2M										
Level	Load	Output power		Mains		Watt *1)			Thermal Dissipation	
				VAC	IAC	In	Out	Dissipated	BTU/hr	kCal/hr
Standby w. remote Power Off.				230	0,032	0,88	0	1	3	1
				120	0,027	0,77	0	1	3	1
				100	0,028	0,76	0	1	3	1
Power On, Idling				230	0,14	14,8	0	15	51	13
				120	0,21	13,4	0	13	46	12
				100	0,25	14,1	0	14	48	12
Pink pseudo noise (1/8)	16 Ω / Ch.	15	x 2	230	0,19	21,5	3,8	18	61	15
				120	0,27	19,1	3,8	15	52	13
				100	0,32	19,9	3,8	16	55	14
	8 Ω / Ch.	30	x 2	230	0,23	26,6	7,5	19	65	16
				120	0,33	23,7	7,5	16	55	14
				100	0,39	24,8	7,5	17	59	15
	4 Ω / Ch.	30	x 2	230	0,23	27,0	7,5	19	67	17
				120	0,33	24,4	7,5	17	58	15
				100	0,39	25,2	7,5	18	60	15
	2 Ω / Ch.	30	x 2	230	0,23	27,7	7,5	20	69	17
				120	0,35	25,1	7,5	18	60	15
				100	0,40	25,9	7,5	18	63	16

*1) The amplifier's PSU operates as a non-resistive load, so the calculation "Volts x Amps = Watts" would not be correct. Instead, measured and specified here is what is known as the "Active Power" in the amplifier providing useful, real-world values of power consumption and heat dissipation.

LUCIA 60/1-70												
Level	Load			Output power		Mains		Watt *1)			Thermal Dissipation	
				VAC	IAC	In	Out	Dissipated	BTU/hr	kCal/hr		
Standby w. remote Power Off.				230	0,032	0,88	0	1	3	1		
				120	0,027	0,77	0	1	3	1		
				100	0,028	0,76	0	1	3	1		
Power On, Idling				230	0,12	11,9	0	12	41	10		
				120	0,19	13,0	0	13	44	11		
				100	0,22	13,1	0	13	45	11		
Pink pseudo noise (1/8)	70 V	60	x 1	230	0,20	23,8	15	9	30	8		
	70 V	60	x 1	120	0,32	23,3	15	8	28	7		
	70 V	60	x 1	100	0,37	23,7	15	9	30	8		

*1) The amplifier's PSU operates as a non-resistive load, so the calculation "Volts x Amps = Watts" would not be correct. Instead, measured and specified here is what is known as the "Active Power" in the amplifier providing useful, real-world values of power consumption and heat dissipation.

LUCIA 120/2														
Level	Load			Output power		Mains voltage		Line current		Watt *1)			Thermal Dissipation	
				VAC	IAC	In	Out	Dissipated	BTU/hr	kCal/hr				
Standby w. remote Power Off.				230	0.032	0.88	0	1	3	1				
				120	0.027	0.77	0	1	3	1				
				100	0.028	0.76	0	1	3	1				
Power on, Idling				230	0.21	11.9	0	12	41	10				
				120	0.19	13.0	0	13	44	11				
				100	0.22	13.1	0	13	45	11				
Pink Pseudo Noise (1/8)	16 Ω / Ch.	30	x 2	230	0.22	25.3	7.5	18	61	15				
				120	0.34	24.3	7.5	17	57	14				
				100	0.40	24.6	7.5	17	58	15				
	8 Ω / Ch.	60	x 2	230	0.30	35.6	15	21	70	18				
				120	0.47	33.6	15	19	63	16				
				100	0.54	34.4	15	19	66	17				
	4 Ω / Ch.	60	x 2	230	0.30	36.3	15	21	73	18				
				120	0.48	34.9	15	20	68	17				
				100	0.55	35.3	15	20	69	17				
	2 Ω / Ch.	60	x 2	230	0.32	37.7	15	23	77	20				
				120	0.50	36.3	15	21	73	18				
				100	0.57	36.6	15	22	74	19				

*1) The amplifier's PSU operates as a non-resistive load, so the calculation "Volts x Amps = Watts" would not be correct. Instead, measured and specified here is what is known as the "Active Power" in the amplifier providing useful, real-world values of power consumption and heat dissipation.

LUCIA 120/2M											
Level	Load			Output power	Mains voltage		Line current			Thermal Dissipation	
					VAC	IAC	In	Out	Dissipated	BTU/hr	kCal/hr
Standby w. remote Power Off.					230	0.032	0.88	0	1	3	1
					120	0.027	0.77	0	1	3	1
					100	0.028	0.76	0	1	3	1
Power on, Idling					230	0.14	14.8	0	15	51	13
					120	0.21	13.4	0	13	46	12
					100	0.25	14.1	0	14	48	12
Pink Pseudo Noise (1/8)	16 Ω / Ch.	30	x 2	230	0.25	28.2	7.5	21	71	18	
				120	0.35	24.7	7.5	17	59	15	
				100	0.41	25.6	7.5	18	62	16	
	8 Ω / Ch.	60	x 2	230	0.33	38.5	15	23	80	20	
				120	0.47	34.0	15	19	65	16	
				100	0.55	35.4	15	20	70	18	
	4 Ω / Ch.	60	x 2	230	0.33	39.2	15	24	83	21	
				120	0.48	35.3	15	20	69	17	
				100	0.56	36.3	15	21	73	18	
	2 Ω / Ch.	60	x 2	230	0.34	40.6	15	26	87	22	
				120	0.51	36.7	15	22	74	19	
				100	0.59	37.6	15	23	77	19	

*1) The amplifier's PSU operates as a non-resistive load, so the calculation "Volts x Amps = Watts" would not be correct. Instead, measured and specified here is what is known as the "Active Power" in the amplifier providing useful, real-world values of power consumption and heat dissipation.

LUCIA 120/1-70											
Level	Load			Output power	Mains		Watt *1)			Thermal Dissipation	
					VAC	IAC	In	Out	Dissipated	BTU/hr	kCal/hr
Standby w. remote Power Off.					230	0,032	0,88	0	1	3	1
					120	0,027	0,77	0	1	3	1
					100	0,028	0,76	0	1	3	1
Power On, Idling					230	0,12	11,9	0	12	41	10
					120	0,19	13,0	0	13	44	11
					100	0,22	13,1	0	13	45	11
Pink pseudo noise (1/8)	70 V	120	x 1	230	0,30	35,6	15	21	70	18	
	70 V	120	x 1	120	0,47	33,6	15	19	63	16	
	70 V	120	x 1	100	0,54	34,4	15	19	66	17	

*1) The amplifier's PSU operates as a non-resistive load, so the calculation "Volts x Amps = Watts" would not be correct. Instead, measured and specified here is what is known as the "Active Power" in the amplifier providing useful, real-world values of power consumption and heat dissipation.

LUCIA 240/2

Level	Load	Output power		Mains voltage	Line current	Watt *1)			Thermal Dissipation	
						In	Out	Dissipated	BTU/hr	kCal/hr
				VAC	IAC					
Standby w. remote Power Off.				230	0.032	0.88	0	1	3	1
				120	0.027	0.77	0	1	3	1
				100	0.028	0.76	0	1	3	1
Power on, Idling				230	0.12	11.9	0	12	41	10
				120	0.19	13.0	0	13	44	11
				100	0.22	13.1	0	13	45	11
Pink Pseudo Noise (1/8)	16 Ω / Ch.	60	x 2	230	0.29	34.4	15	19	66	17
				120	0.47	34.7	15	20	67	17
				100	0.58	34.1	15	19	65	16
	8 Ω / Ch.	120	x 2	230	0.42	53.7	30	24	81	20
				120	0.70	54.2	30	24	82	21
				100	0.81	54.6	30	25	86	21
	4 Ω / Ch.	120	x 2	230	0.45	55.2	30	25	86	22
				120	0.74	56.7	30	27	91	23
				100	0.84	56.8	30	27	91	23
	2 Ω / Ch.	120	x 2	230	0.47	59.1	30	29	99	25
				120	0.76	58.9	30	29	98	25
				100	0.91	61.1	30	31	106	27

*1) The amplifier's PSU operates as a non-resistive load, so the calculation "Volts x Amps = Watts" would not be correct. Instead, measured and specified here is what is known as the "Active Power" in the amplifier providing useful, real-world values of power consumption and heat dissipation.

LUCIA 240/2M

Level	Load	Output power		Mains voltage	Line current	Watt *1)			Thermal Dissipation	
						In	Out	Dissipated	BTU/hr	kCal/hr
				VAC	IAC					
Standby w. remote Power Off.				230	0.032	0.88	0	1	3	1
				120	0.027	0.77	0	1	3	1
				100	0.028	0.76	0	1	3	1
Power on, Idling				230	0.14	14.8	0	15	51	13
				120	0.21	13.4	0	13	46	12
				100	0.25	14.1	0	14	48	12
Pink Pseudo Noise (1/8)	16 Ω / Ch.	60	x 2	230	0.31	37.3	15	22	76	19
				120	0.48	35.1	15	20	69	17
				100	0.60	35.1	15	20	69	17
	8 Ω / Ch.	120	x 2	230	0.45	56.6	30	27	91	23
				120	0.71	54.6	30	25	84	21
				100	0.83	55.6	30	26	87	22
	4 Ω / Ch.	120	x 2	230	0.47	58.1	30	28	96	24
				120	0.75	57.1	30	27	92	23
				100	0.86	57.8	30	28	95	24
	2 Ω / Ch.	120	x 2	230	0.49	62.0	30	32	109	28
				120	0.77	59.3	30	29	100	25
				100	0.93	62.1	30	32	110	28

*1) The amplifier's PSU operates as a non-resistive load, so the calculation "Volts x Amps = Watts" would not be correct. Instead, measured and specified here is what is known as the "Active Power" in the amplifier providing useful, real-world values of power consumption and heat dissipation.

LUCIA 240/1-70														
Level	Load			Output power			Mains			Watt *1)			Thermal Dissipation	
				VAC	IAC	In	Out	Dissipated	BTU/hr	kCal/hr				
Standby w. remote Power Off.				230	0,032	0,88	0	1	3	1				
				120	0,027	0,77	0	1	3	1				
				100	0,028	0,76	0	1	3	1				
Power On, Idling				230	0,12	11,9	0	12	41	10				
				120	0,19	13,0	0	13	44	11				
				100	0,22	13,1	0	13	45	11				
Pink pseudo noise (1/8)	70 V	240	x 1	230	0,42	53,7	30	24	81	20				
	70 V	240	x 1	120	0,70	54,2	30	24	82	21				
	70 V	240	x 1	100	0,81	54,6	30	25	84	21				
<p>*1) The amplifier's PSU operates as a non-resistive load, so the calculation "Volts x Amps = Watts" would not be correct. Instead, measured and specified here is what is known as the "Active Power" in the amplifier providing useful, real-world values of power consumption and heat dissipation.</p>														

15.6. Technical Specifications

General	LUCIA 240/2M	LUCIA 120/2M	LUCIA 60/2M
Number of powered channels	2	2	2
Total output all channels driven	240 W	120 W	60 W
Max output voltage per channel 1)	43.8 Vpeak	31 Vpeak	21.9 Vpeak
Max output current per channel	7.8 Arms	5.5 Arms	3.9 Arms
Max Output Power (all channels driven)			
2 ohms	120 W	60 W	30 W
4 ohms	120 W	60 W	30 W
8 ohms	120 W	60 W	30 W
16 ohms	60 W	30 W	15 W
Performance			
THD 20 Hz - 20 kHz at 1 W into 8 ohms	<0.3%	<0.3%	<0.3%
THD 1kHz and 1 dB below clipping	<0.2%	<0.2%	<0.2%
Signal to noise ratio into 8 ohms	>101 dBA	>98 dBA	>95 dBA
Channel separation (Crosstalk) at 1 kHz	>60 dB	>60 dB	>60 dB
Frequency response	5 Hz – 22 kHz	5 Hz – 22 kHz	5 Hz – 22 kHz
Input impedance	10 kOhm	10 kOhm	10 kOhm
Input common mode rejection, CMR	40 dB	40 dB	40 dB
Gain, Sensitivity and Limiters			
VPL for 16 ohm mode	44 Vpeak	31 Vpeak	21.9 Vpeak
VPL for 8 ohm mode	44 Vpeak	31 Vpeak	21.9 Vpeak
VPL for 4 ohm mode	31 Vpeak	22 Vpeak	15.5 Vpeak
VPL for 2 ohm mode	22 Vpeak	15 Vpeak	11 Vpeak
Sensitivity, balanced output	4 dBu / 1.23 Vrms	4 dBu / 1.23 Vrms	4 dBu / 1.23 Vrms
Sensitivity, RCA input	-2 dBu / 0.62 Vrms	-2 dBu / 0.62 Vrms	-2 dBu / 0.62 Vrms
Input headroom for clip, balanced 2)	12 dBu / 3.09 Vrms	12 dBu / 3.09 Vrms	12 dBu / 3.09 Vrms
Input headroom for clip, RCA 2)	6 dBu / 1.55 Vrms	6 dBu / 1.55 Vrms	6 dBu / 1.55 Vrms
Connectors and buttons			
Input connectors (per channel)	3 - pin detachable screw terminals, electronically balanced		
Input connectors (ch. 1 & 2)	Unbalanced RCA type		
Output connectors (per channel)	2 - pin detachable screw terminals		
Line-level output connectors (ch. 3 & 4)	3 - pin detachable screw terminals, electronically balanced		
GPI (power control input) 3)	2 channels of voltage sense type. 4 pins in a detachable screw terminal. Default for gain.		
GPO (power state output) 3)	Contact closure type, 2 pins in a detachable screw terminal. Default for external monitoring of fault/protection/power off		
RS232	Can be controlled and monitored by third parties via RS232 using both the GPI pins		
USB	For firmware update and configuration for the matrix models		
Level adjustment (per channel) 3)	Front panel potentiometer, detented from -inf to 0 dB		
Matrix model features			
Inputs processing block 4)	4 EQ sections per input		
Mix-matrix routing block 4)	4 in - 4 out mix-matrix controllable from GPI		
Output processing block 4)	4 EQ sections per output (presets available for many loudspeakers) User adjustable output look ahead limiter ADLC (Adaptive ISO 226 compensation)		
Two line level outputs 5)	Each capable of driving 6 LUCIA units in parallel		
Latency from any input to any output	User adjustable from 9.15 to 137 ms		
Power			
Nominal voltage	100 – 240 VAC		
Operating voltage	85 - 265 VAC		
Standby consumption	<1 W		
Mains connector	IEC inlet		
Cooling	One fan, no filter required, front-to-rear air ow, temperature controlled speed. Can stay off if the sustained power average stays below 2 x 6 W and the surrounding temperature is below 25 degrees C		
Auto mode	The power state is controlled automatically with the audio signal		
Dimensions			
	W: 216 mm (8.5"), H: 44 mm (1.7"), D: 280 mm (11")		
Weight	1.9 kg (4.2 lbs)		
Finish	Black aluminium front and black steel chassis		
Approvals	CE, CSA, CCC, PSE, FCC, ENERGY STAR		

Note 1): Into 8 ohms and higher

Note 2): An analog soft limit will be engaged on the input above this level to reduce the clip distortion

Note 3): Can be configured for different functionality via USB

Note 4): DSP settings determined by settings downloaded from the Application Browser software; not configurable on the unit itself

Note 5): Noise levels typically allow daisy chaining of 3 LUCIA amplifiers without issues

All specifications are subject to change without notice.

General	LUCIA 240/2	LUCIA 120/2	LUCIA 60/2
Number of powered channels	2	2	2
Total output all channels driven	240 W	120 W	60 W
Max output voltage per channel 1)	43.8 Vpeak	31 Vpeak	21.9 Vpeak
Max output current per channel	7.8 Arms	5.5 Arms	3.9 Arms
Max Output Power (all channels driven)			
2 ohms	120 W	60 W	30 W
4 ohms	120 W	60 W	30 W
8 ohms	120 W	60 W	30 W
16 ohms	60 W	30 W	15 W
Performance			
THD 20 Hz - 20 kHz at 1 W into 8 ohms	<0.3%	<0.3%	<0.3%
THD 1kHz and 1 dB below clipping	<0.2%	<0.2%	<0.2%
Signal to noise ratio into 8 ohms	>101 dBA	>98 dBA	>95 dBA
Channel separation (Crosstalk) at 1 kHz	>60 dB	>60 dB	>60 dB
Frequency response	5 Hz – 22 kHz	5 Hz – 22 kHz	5 Hz – 22 kHz
Input impedance	10 kOhm	10 kOhm	10 kOhm
Input common mode rejection, CMR	40 dB	40 dB	40 dB
Gain, Sensitivity and Limiters			
VPL for 16 ohm mode	44 Vpeak	31 Vpeak	21.9 Vpeak
VPL for 8 ohm mode	44 Vpeak	31 Vpeak	21.9 Vpeak
VPL for 4 ohm mode	31 Vpeak	22 Vpeak	15.5 Vpeak
VPL for 2 ohm mode	22 Vpeak	15 Vpeak	11 Vpeak
Sensitivity, balanced output	4 dBu / 1.23 Vrms	4 dBu / 1.23 Vrms	4 dBu / 1.23 Vrms
Sensitivity, RCA input	-2 dBu / 0.62 Vrms	-2 dBu / 0.62 Vrms	-2 dBu / 0.62 Vrms
Input headroom for clip, balanced 2)	12 dBu / 3.09 Vrms	12 dBu / 3.09 Vrms	12 dBu / 3.09 Vrms
Input headroom for clip, RCA 2)	6 dBu / 1.55 Vrms	6 dBu / 1.55 Vrms	6 dBu / 1.55 Vrms
Connectors and buttons			
Input connectors (per channel)	3 - pin detachable screw terminals, electronically balanced		
Input connectors (ch. 1 & 2)	Unbalanced RCA type		
Output connectors (per channel)	2 - pin detachable screw terminals		
GPI (power control input) 3)	2 channels of voltage sense type. 4 pins in a detachable screw terminal. Default for gain.		
GPO (power state output) 3)	Contact closure type, 2 pins in a detachable screw terminal. Default for external monitoring of fault/protection/power off		
RS232	Can be controlled and monitored by third parties via RS232 using both the GPI pins		
USB	For firmware update and configuration for the matrix models		
Level adjustment (per channel) 3)	Front panel potentiometer, detented from -inf to 0 dB		
Matrix model features			
Inputs processing block 4)	4 EQ sections per input		
Mix-matrix routing block 4)	2 in - 2 out mix-matrix controllable from GPI		
Output processing block 4)	4 EQ sections per output (presets available for many loudspeakers) User adjustable output look ahead limiter ADLC (Adaptive ISO 226 compensation)		
Latency from any input to any output	User adjustable from 9.15 to 137 ms		
Power			
Nominal voltage	100 – 240 VAC		
Operating voltage	85 - 265 VAC		
Standby consumption	<1 W		
Mains connector	IEC inlet		
Cooling	One fan, no filter required, front-to-rear air ow, temperature controlled speed. Can stay off if the sustained power average stays below 2 x 6 W and the surrounding temperature is below 25 degrees C		
Auto mode	The power state is controlled automatically with the audio signal		
Dimensions			
	W: 216 mm (8.5"), H: 44 mm (1.7"), D: 280 mm (11")		
Weight			
	1.9 kg (4.2 lbs)		
Finish			
	Black aluminium front and black steel chassis		
Approvals			
	CE, CSA, CCC, PSE, FCC, ENERGY STAR		

Note 1): Into 8 ohms and higher

Note 2): An analog soft limit will be engaged on the input above this level to reduce the clip distortion

Note 3): Can be configured for different functionality via USB

Note 4): DSP settings determined by settings downloaded from the Application Browser software; not configurable on the unit itself

All specifications are subject to change without notice.

General	LUCIA 240/1-70	LUCIA 120/1-70	LUCIA 60/1-70
Number of powered channels	1	1	1
Total output all channels driven	240 W	120 W	60 W
Max output voltage	100 V peak	100 V peak	100 V peak
Max output current	7 Arms	3.5 Arms	1.8 Arms
Performance			
70 V	240 W	120 W	60 W
100 V 1)	120 W	60 W	30 W
16 ohms	240 W	120 W	60 W
Signal to Noise Ratio	>100 dBA	>100 dBA	>100 dBA
Gain, Sensitivity and Limiters			
VPL	100 V peak	100 V peak	100 V peak
Sensitivity, balanced output	4 dBu / 1.23 Vrms	4 dBu / 1.23 Vrms	4 dBu / 1.23 Vrms
Sensitivity, RCA input	-2 dBu / 0.62 Vrms	-2 dBu / 0.62 Vrms	-2 dBu / 0.62 Vrms
Input headroom for clip, balanced 2)	12 dBu / 3.09 Vrms	12 dBu / 3.09 Vrms	12 dBu / 3.09 Vrms
Input headroom for clip, RCA 2)	6 dBu / 1.55 Vrms	6 dBu / 1.55 Vrms	6 dBu / 1.55 Vrms
Connectors and buttons			
Input connectors (per channel)	3 - pin detachable screw terminals, electronically balanced		
Input connectors (ch. 1 & 2)	Unbalanced RCA type		
Output connector	2 - pin detachable screw terminals		
GPI (power control input) 3)	2 channels of voltage sense type. 4 pins in a detachable screw terminal. Default for gain.		
GPO (power state output) 3)	Contact closure type, 2 pins in a detachable screw terminal. Default for external monitoring of fault/protection/power off		
RS232	Can be controlled and monitored by third parties via RS232 using both the GPI pins		
USB	For firmware update and configuration for the matrix models		
High pass filter	This filter is in series with the other filters in the DSP and it is controlled with switches on the back. Settings OFF / 50 Hz / 80 Hz.		
Level adjustment (per input)	Front panel potentiometer, detented from -inf to 0 dB		
Matrix model features			
Inputs processing block 4)	4 EQ sections per input		
Mix-matrix routing block 4)	2 in - 1 out mix-matrix controllable from GPI		
Output processing block 4)	4 EQ sections per output (presets available for many loudspeakers) User adjustable output look ahead limiter ADLC (Adaptive ISO 226 compensation)		
Latency from any input to any output	User adjustable from 9.15 to 137 ms		
Power			
Nominal voltage	100 – 240 VAC		
Operating voltage	85 - 265 VAC		
Standby consumption	<1 W		
Mains connector	IEC inlet		
Cooling	One fan, no filter required, front-to-rear air ow, temperature controlled speed. Can stay off if the sustained power average stays below 2 x 6 W and the surrounding temperature is below 25 degrees C		
Auto mode	The power state is controlled automatically with the audio signal		
Dimensions	W: 216 mm (8.5"), H: 44 mm (1.7"), D: 280 mm (11")		
Weight	1.9 kg (4.2 lbs)		
Finish	Black aluminium front and black steel chassis		
Approvals	CE, CSA, CCC, PSE, FCC, ENERGY STAR		

Note 1): The peak voltage is 100 V, but the look-ahead limiter solution ensures that it cannot clip, so in real life use with music or speech it will typically be able to sustain a higher SPL in 100 V applications than 100 V amplifiers with higher peak voltage capability as the amplifier have the capacity to handle peaks way beyond "clip" without sounding harsh.

Note 2): An analog soft limit will be engaged on the input above this level to reduce the clip distortion

Note 3): Can be configured for different functionality via USB

Note 4): DSP settings determined by settings downloaded from the Application Browser software; not configurable on the unit itself

All specifications are subject to change without notice.

16. FAQ

Is the LUCIA power stage inherently bridged as on E Series, thereby allowing asymmetrical loading?

No, the power output limit per channel is fixed on LUCIA. The amplifier cannot be bridged and there is no way to use power on one channel that is not being used on the other, as with Lab.gruppen's E Series. However, the channels are **automatically optimized** when it comes to peak voltage, enabling one channel to deliver the full rated power into 2 ohms and the other channel into 8 ohms.

What is the meaning and importance of "Input headroom for clip" in the technical specifications?

This is the level at which the input signal will reach full level on the input to the DSP. Above this level, the signal will be severely compressed by an analog soft-clip circuit.

How many inputs can be driven by a LUCIA M line output?

Each LUCIA balanced line level output can drive up to 6 inputs in parallel; these can be any combination of LUCIA, E Series, or C Series amplifiers (or other 20 kOhm balanced inputs).

Why is there latency (delay) through LUCIA?

The latency through a LUCIA is 9.15 ms (acoustically equivalent of 10 ft or 3 m). This is primarily due to the look-ahead limiters and to the multiband mastering compression used in our ADLC algorithm, which adjusts for the nonlinearities of the ear (ISO226). The 9.15 ms of latency is below what is detectable as out-of-sync when used in video sound applications. Nevertheless, in some applications, it is preferable to drive multiple LUCIA units in parallel rather than in a series ('daisy chain') configuration, as this will result in incremental delays.

What limiter circuits are incorporated into LUCIA, and how do they operate?

Following is a simplified description of the LUCIA limiters:

- Short term (<60 ms), look-ahead voltage peak limiter - The threshold of this limiter is automatically trimmed by an instantaneous impedance measurement when the amplifier goes out of standby. This automatic adjustment ensures that the threshold does not exceed the rated power or the maximum current that the amplifier can deliver. In LUCIA two output low impedance models, alternate presets may be used that designed for a lower power output than the full output allowed by the default preset.
- Medium term limiter - This limiter is inserted to avoid clipping if the power supply rail sags.
- Long term (>0.5 s) - This limiter is inserted to prevent thermal problems.

labgruppen.com