



**400A Series Multifunction Clocks
and Calendar Clocks**

**Operating and Installation
Instructions**

Contents

Introduction	
Operating Modes	1
Installation	3
Power Supply Connection	3
External Signal Connection	3
Manual Time Synchronisation	3
Optional Internal Interfaces	3
Guarantee	3
Time and Date Setting	4
Function Programming	6
Programmable Options	7
Special Display Modes	10
EBU/SMPTE Code Formats	11
Serial ASCII Data Formats	12
Up/Down Stopwatch Operation with 402A Stopwatch Controller	
Introduction	13
Programmable options	14
402A Stopwatch Controller Function Programming	15
402A Stopwatch Controller Operating Modes	16
Simple Stopwatch Operation with 496A Stopwatch Controller	18
Optional Internal Interfaces	
Installation	20
Interface Function Options	21
Special Operating Modes	
Temperature Display	22
Local Master Clock Mode	22
Radio Time Code Synchronisation	23
Mounting Details	
400A.02 Series DIN Cased Panel Mounting Clocks	24
Ceiling Suspended Cases	25
Flush Mounting Cases	26
Surface Mounting Cases	27
External Interface Connections	28
Program Record Sheet	Inside rear cover

Operating Modes

The 400A family of electronic digital clocks and calendar clocks allows a wide range of user programmable operating modes as detailed below. To program the required functions please refer to the Function Programming instructions starting on page 6. For a full description of the various program function selection options please refer to pages 7 to 9.

- automatic or manual control of display brightness - *program function 1*.
- 12 or 24 hour display selection - *program function 2*.
- Stand-alone operation - *program function 3, selection 1* - **or** synchronisation from :
 - ~ Uni-polar or alternate polarity signals, 6 - 24v, at a one second, half minute or one minute repetition rate - *program function 3, selections 2 to 7*.
 - ~ W482 time code signals with selection of one of fifteen different time zones - *program function 3, selection 8*.
 - ~ MSF or DCF radio time code signals when used in conjunction with a 484 series radio time code receiver. The displayed time may be either CET when synchronised to DCF signals, BST when synchronised to MSF signals or UTC (GMT) when synchronised to either DCF or MSF signals - *program function 3, selections 9 to 12*. Please refer to page 23 of this manual for further information.
 - ~ IRIG-B or afnor NF S 87- 500 time code signals - requires optional 404.I internal interface for modulated sine wave signals or 404.4 internal interface for RS485 level logic signals - *program function 3, selections 13 & 14*.
 - ~ EBU or SMPTE signal in either of two date formats - requires optional 404.E internal interface - *program function 3, selections 15 & 16*.
 - ~ W482 time code from a 400A series clock used as a local master to synchronise up to 10 other 400A series clocks acting as slaves and located within 200 metres. The 400A clock used as a local master requires the internal 404.M interface option. The clock used as the local master may derive its time keeping from its internal crystal or be synchronised to radio time code signals. Please refer to page 22 of this manual for further information.
 - ~ RS232 or RS485 serial ascii data in one of three message formats - *program function 3, selections 18 to 20*; at 1200, 2400, 4800, or 9600 baud - *program function 10* - with seven or eight data bits - *program function 11* - and odd or even parity- *program function 12*. Serial ascii synchronisation requires either the optional internal 404.2 (RS232) or 404.4 (RS485) interface. Refer to page 12 for details of serial formats.
 - ~ GPS satellite time signals displayed either as UTC or as local time with up to ± 13 hours offset - *program function 6*, from UTC with pre-programmable seasonal time-change offset corrections - requires 488GPS antenna and receiver/interface - *program function 3, selection 23*.
- The display can be programmed to blank or stop in the event of synchronising code failure or to continue to count, using the internal high stability quartz crystal timebase, from the last valid signal received - *program function 4*.
- Time only clocks (401A, 420A and 490A models) can be programmed for use as a stopwatch, when used with a 496A control panel, to count time in hours, minutes and seconds or minutes, seconds and 1/100th seconds (hours and minutes or minutes and seconds for model 420A) - *program function 7, selection 1 or 2*. Please refer to pages 18 & 19 of this manual for further information.
- The 401A, 420A and 490A models can be programmed for use with a type 402A control panel to give the ability to switch between time-of-day and stopwatch time. The time-of-day count may be stand-alone or synchronised to remote impulse or code master clocks or radio time code signals. The stopwatch time can be programmed to count down from a user pre-programmed time value, stopping at or counting through zero, or to count up from zero. Five user selectable count-hold-reset modes are available for different timing applications - *program function 7, selection 3*. Please refer to pages 13 to 17 of this manual for further information.

Introduction - 2

- All models may be programmed to provide one of seven serial RS232 ascii data output messages when used in stand-alone or radio-synchronised modes - *program function 9*. The output messages may be either every second, after receipt of an ascii `T' or `t' - *program function 7, selection 4*) or on a voltage free switch closure - *program function 7, selection 5*. The output messages may be at 1200, 2400, 4800, or 9600 baud - *program function 10* - , with seven or eight data bits - *program function 11* - and odd or even parity - *program function 12*. Requires optional internal 404.2 (RS232) interface. Please refer to pages 12 and 20 - 21 of this manual for further information.
- All models may be programmed to provide an alternating time/temperature display - *program function 7, selections 6 or 7* - with user selection of the time interval between display changes - *program function 13* . The display temperature may be adjusted to correct errors due to sensor location and calibration. - requires optional temperature sensor. Please refer to page 22 of this manual for further information.
- All models may be programmed for automatic seasonal time changes in accordance with European, UK or US change-over patterns - *program function 14* . Manual selection of the appropriate change-over month and Sunday (first, second, third, fourth or last in month) is normally once-only.
- The 450A, 451A, 452A, 453A, 454A and 460A calendar clocks may be programmed for four alternate date displays to show:
 - ~ Julian date (the day of year) in place of day-of-week display - *program function 15, selection 2*
 - ~ Week number in place of day-of-week display - *program function 15, selection 3*
The first Monday in each year is taken as the start of week 1.
 - ~ Numeric day-month-year display - *program function 15, selection 4*
 - ~ Numeric month-day-year display - *program function 15, selection 5*
- The date display of calendar clocks may be programmed to display one, two, or three languages - *program functions 16 to 19* - from those listed below. If two or three languages are selected the display changes at a user-selectable rate - *program function 13*.

~ Catalonian	- selection CA	~ Czech	- selection CR
~ German	- selection D	~ Danish	- selection DK
~ Spanish	- selection E	~ French	- selection F
~ Galician	- selection GA	~ English	- selection GB
~ Hungarian	- selection H	~ Croat	- selection HR
~ Italian	- selection I	~ Norwegian	- selection N
~ Dutch	- selection NL	~ Portuguese	- selection P
~ Polish	- selection PL	~ Russian	- selection RU
~ Swedish	- selection S	~ Finnish	- selection SF
~ Slovak	- selection SK	~ Slovenian	- selection SL
~ Welsh	- selection W		

Installation

400A series clocks are available with cases suitable for surface wall mounting, flush mounting in a panel with rear access, flush mounting in a wall box and single or double sided ceiling suspension. The surface wall mounting case is supplied with special mounting brackets to enable the angle of the front face of the clock to

be varied to reduce or eliminate unwanted reflections. Please refer to pages 24 to 28 for further mounting information.

Power Supply Connection

400A series clocks may be supplied for 230v ac, 110/120v ac, 12v dc, 24v dc or 48v dc. The clock must be connected to the appropriate supply after first verifying the correct voltage by reference to the supply voltage label fixed to or printed on the rear panel of the clock.

A connection to the earth line must be made to ensure safe operation and ensure compliance with EMC regulations.

To ensure conformance with EN60950:

(A) For installations where the 400A clock is to be permanently connected into the mains power circuit, a readily accessible disconnect device should be incorporated in the fixed wiring.

(B) For installations where the 400A clock is to be plugged into the mains power circuit, a socketed outlet should be installed near the equipment and should be easily accessible.

All installation work should be performed in accordance with the Sixteenth Edition of the IEE Wiring Regulations.

An internal automatically re-charging battery will, when fully charged, maintain the internal time count for a period normally in excess of 60 hours if the mains supply is interrupted.

The power supply is fitted with an internal 100mA fuse (450A, 490A.05 etc = 160mA fuse). In case of fault the fuse should only be replaced by a suitably qualified engineer **after disconnection from the mains power supply** and correction of the fault condition.

External Signal Connection

A six way terminal block is located on the rear panel of the clock to enable the connection of external signals. Details of the connections for various signal configurations are shown on page 28.

The mains power supply must be disconnected when making connections to external signals.

Manual Time Synchronisation

The 400A clock or calendar clock should be set to time of day, when used in stand-alone mode, prior to the connection of a synchronising impulse signal or in the absence of the required synchronising code or radio signal, by means of the three time setting switches located on the rear of the clock. The locations of these switches are illustrated on pages 24 and 28 and the setting sequence is detailed on pages 4 and 5.

401A, 420A and 490A series clocks which normally display time only may also be set to date in order to enable automatic pre-programmed seasonal time-changes and to provide date information for serial ascii data outputs if an optional internal serial interface module is fitted.

Optional Internal Interfaces

A range of optional internal interfaces allow connection of the clock to a variety of signals and external equipment. The appropriate interfaces are normally factory fitted in accordance with order specification.

If it is necessary to fit a new internal interface in order to change the specification of the clock the work must be carried out by a suitably qualified engineer in accordance with the instructions on page 20.

Guarantee

The 400A series clocks are fully guaranteed, on a return to works basis, against failure due to faulty parts or workmanship for one year from date of purchase. In the event of failure, either within or outside the warranty period, please pack the unit with care and return it to our factory for examination and repair.

Time and Date Setting - 1

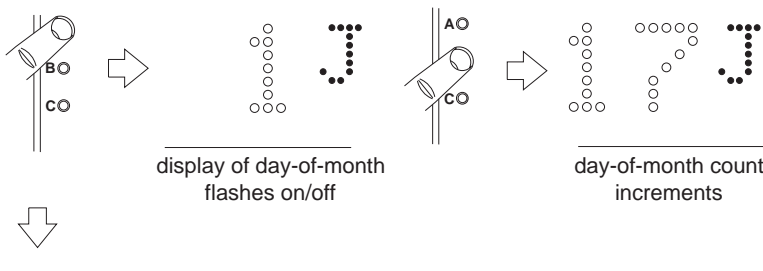
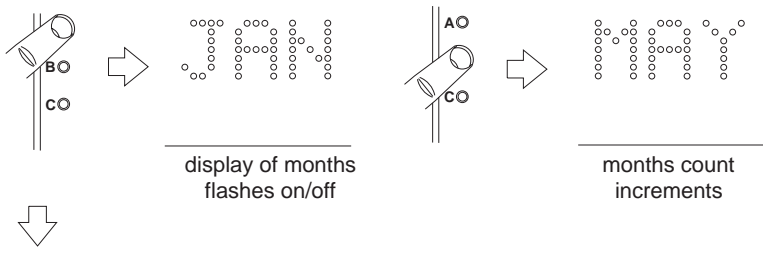
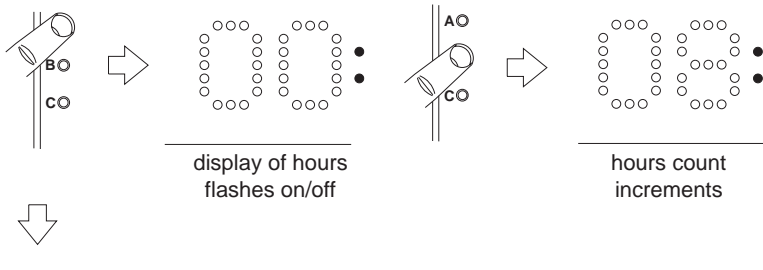
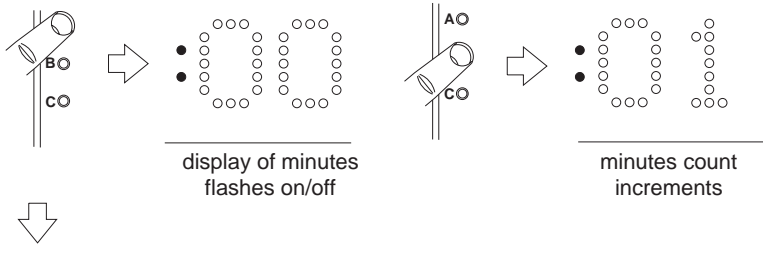
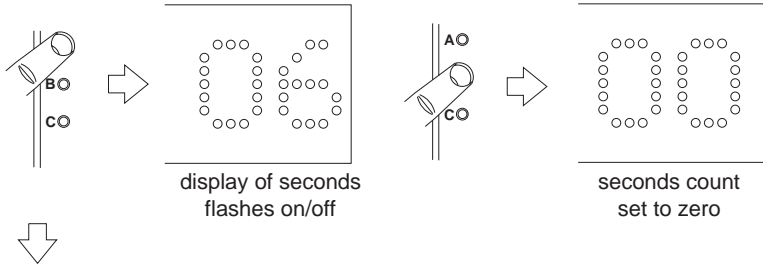
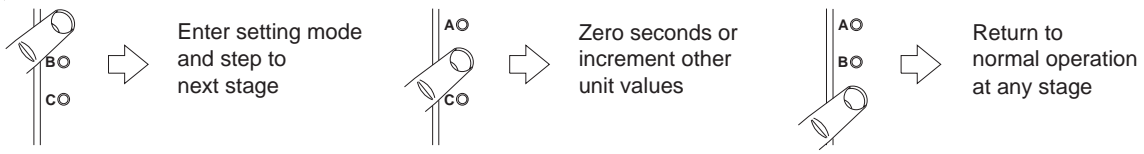

Display for 401 & 420

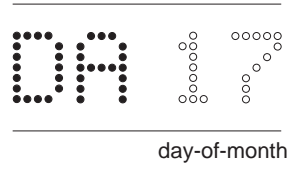
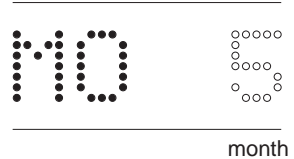

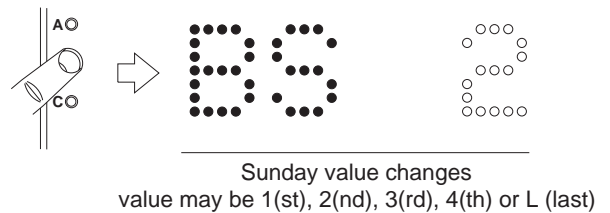
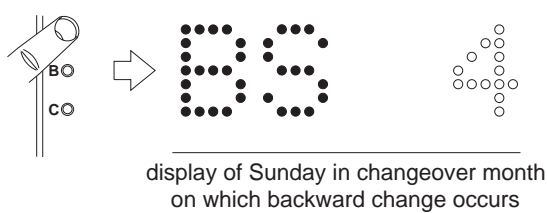
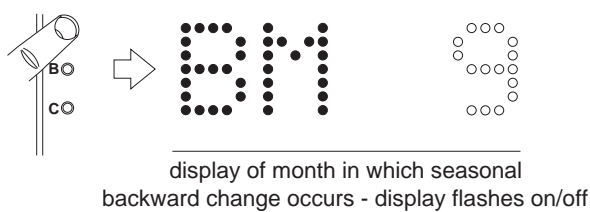
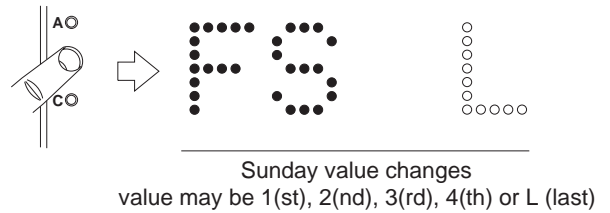
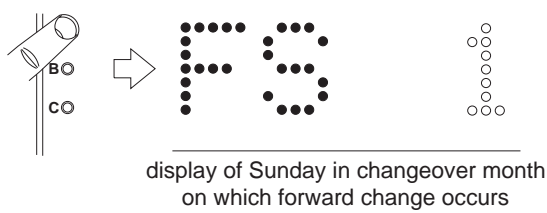
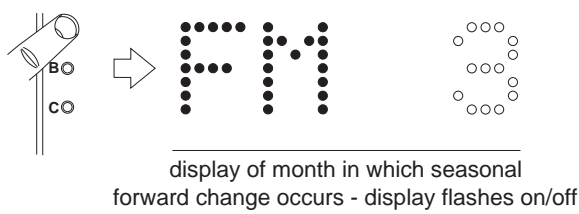
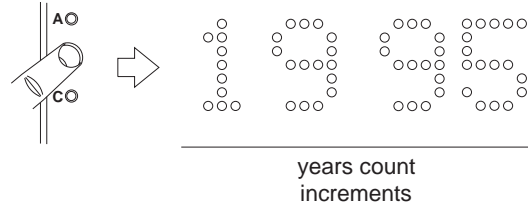
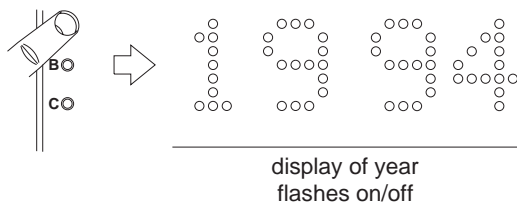
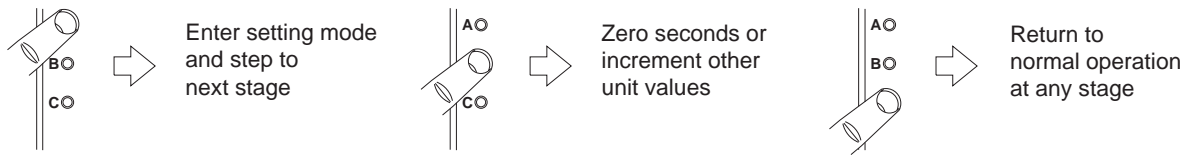

Return to normal operation

Function Programming

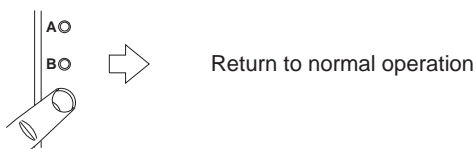
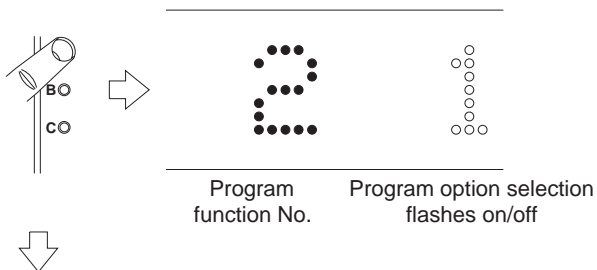
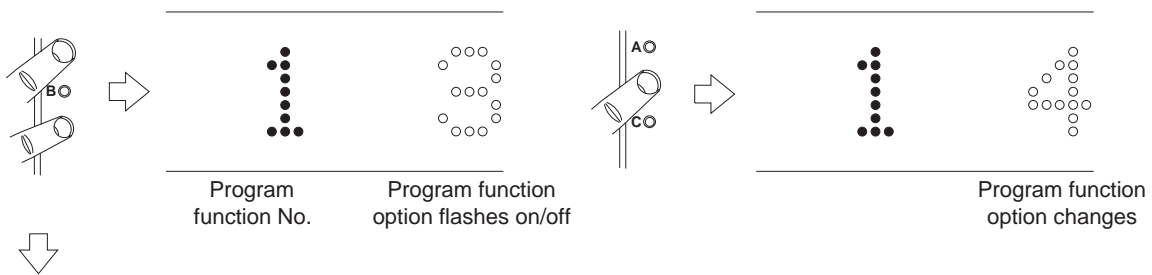
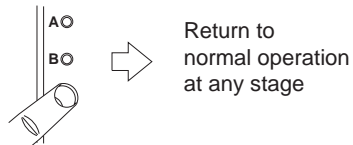
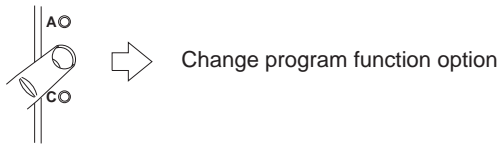
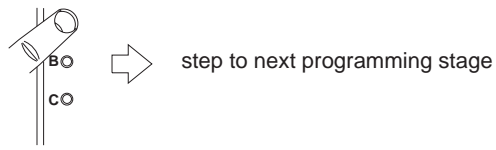

Note:

- Following the display of the last appropriate program option selection the version number of the software will be shown i.e. U 40 = software version 4.0.
- A table is provided on the inside rear cover of this manual for recording the user selected program settings. It is recommended that the installed settings are recorded in this sheet in case of incorrect or unauthorized adjustment of the program settings.
- If all three switches are pressed together a display test will be performed.

95126.

Issue 2.2

Prog. No.	Function	Selection Options	Comments
1	Display brightness	A = Automatic 7 = brightest manual setting ~ 1 = dimmest manual setting	
2	Hour display mode	12 = 12 hour display 24 = 24 hour display	
3	Synchronisation mode	1 = Stand-alone operation 2 = one second uni-polar impulse 3 = one second alternate polarity impulse 4 = half minute uni-polar impulse 5 = half minute alternate polarity impulse 6 = one minute uni-polar impulse 7 = one minute alternate polarity impulse 8 = W482 time code 9 = MSF time code - BST display 10 = MSF time code - UTC(GMT) display 11 = DCF time code - CET display 12 = DCF time code - UTC display 13 = IRIG-B time code 14 = afnor NF S 87- 500 time code 15 = EBU/SMPTE time code - refer to page 11 16 = EBU/SMPTE time code - refer to page 11 17 = Slave to local 400A master 18 = RS232/RS485 serial ascii format (1) 19 = RS232/RS485 serial ascii format (2) 20 = RS232/RS485 serial ascii format (6) 21 = H310 serial time code 22 = Mobaline® time code 23 = GPS time code	Uses internal crystal 6-24v 6-24v 6-24v 6-24v 6-24v 6-24v Code from 482 or 4850 series master clock requires appropriate 484 series radio time code receiver requires 404.I interface, - set year manually. requires 404.I interface requires 404.E interface requires 404.E interface requires 404.2 (RS232) or 404.4 (RS485) interface refer to 488GPS manual -for further information
4	Run mode	1 = blank if code fails 1 = display last message for - 2 = setable to time and date, continue to count with colons flashing when not synchronised	W482, H310, Mobaline & GPS synchronisation only. EBU, IRIG and serial ASCII codes only.

Programmable Options - 2

Prog. No.	Function	Selection Options	Comments
5	Time zone	1 = Zone number ~ F	Only available when synchronised to W482 time code from 482 or 4850 series master clock
6	GPS time offset	+13 = Local time difference from UTC in hours ~ -13	Only required when synchronised to 488GPS system
7	External controller mode	0 = no external controller 1 = 496A stopwatch controller with HH:MM:SS display (HH:MM with 420A) 2 = 496A stopwatch controller with MM:SS:1/100 sec display (MM:SS with 420A series) 3 = 402A up/down stopwatch controller with time/stopwatch display selection 4 = Serial ascii code on demand - triggered by ascii 'T' or 't' input 5 = Serial ascii code on demand - triggered by voltage free switch closure C = Alternate time/temperature display °C ° = Continuous temperature display °C	Only with 401A,420A or 490A series clocks Requires 404.2 interface Requires 404.2 interface Requires 406 temperature sensor
8	Temperature adjustment mode	+5° = Temperature sensor adjustment to correct for sensor calibration and mounting errors ~ - 5°	Only required when 406 temperature sensor connected
9	Serial Output format	0 = No serial output - setting for 'Local Master' mode. 1 = Seconds to years + status 2 = Years to seconds 3 = Years to seconds + status 4 = Years to seconds + $\frac{1}{100}$ sec 5 = Years to seconds + $\frac{1}{100}$ sec + status 6 = Hours, minutes, seconds 7 = Hours, minutes, seconds + $\frac{1}{100}$ sec	Requires 404.M interface for 'Local Master' mode. Selections 9.1 to 9.7 require 404.2 RS232 interface module. External controller mode must be set to 0,6 or 7 for 'Local Master' mode or 0,4,5,6, or 7 for serial outputs.
10	Baud rate	12 = 1200 baud 24 = 2400 baud 48 = 4800 baud 96 = 9600 baud	Only required when synchronised to serial ascii code or serial ascii output required

Prog. No.	Function	Selection Options	Comments
11	Bit length	7 = 7 data bits 8 = 8 data bits	
12	Parity	O = odd parity E = even parity	
13	Hold time	1 = delay in seconds between changes in languages or between time and temperature display ~ 15	
14	Seasonal time change-over mode	— = no change-over mode set GB = British change-over pattern EU = European change-over pattern US = American change-over pattern	forwards backwards 1:00 - 2:00 2:00 - 1:00 2:00 - 3:00 3:00 - 2:00 2:00 - 3:00 2:00 - 1:00
15	Special display modes	1 = Standard display 2 = Modes 2 - 5 available on 450A, 452A, 453A and 454A calendar clocks ~ 5 2 = Modes 2 - 6 available on 490A.02 and 490A.05 clocks ~ 6 7 = Modes 7, 8 available on 401A and 420A clocks ~ 8	See page 10 for illustration of special display modes. Alternating date and time display on 401A & 420A. 7 = day-of-month, month 8 = month, day-of-month
16	Number of languages display	1 = one language 2 = two languages 3 = three languages	Only required for calendar clocks
17 - 19	First, second and third language selections	CA = Catallonian CR = Czech D = German DK = Danish E = Spanish F = French GA = Galicain GB = English H = Hungarian HR = Croat I = Italian N = Norwegian NL = Dutch P = Portuguese PL = Polish RU = Russian S = Swedish SF = Finnish SK = Slovak SL = Slovenian W = Welsh	

Special Display Formats

Special Display Modes for 450A, 452A, 453A and 454A Calendar Clocks

Display mode 1

TUE 29 JUN
day-of-week day-of-month month

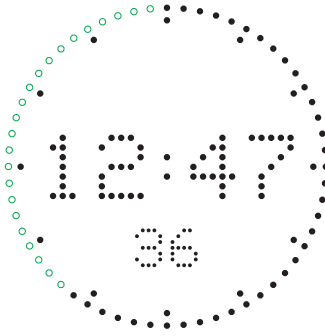

Display mode 2

180 29 JUN
day-of-year day-of-month month

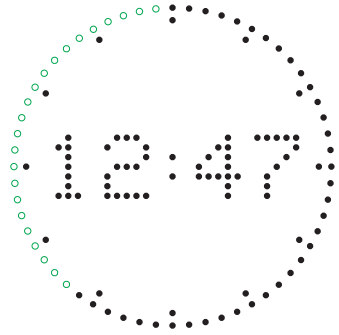

Display mode 3

W26 29 JUN
week-number day-of-month month

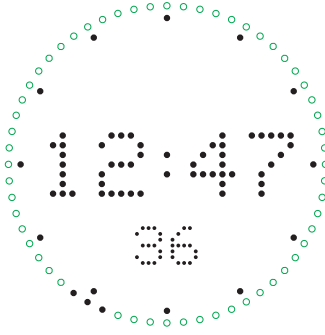

Display mode 4

29 06 95
day-of-month month year

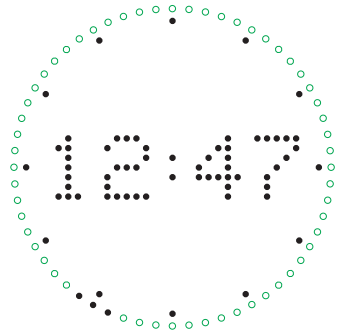

Display mode 5

06 29 95
month day-of-month year

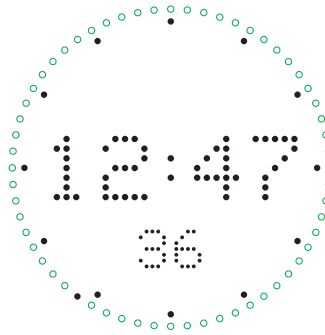

Display mode 6

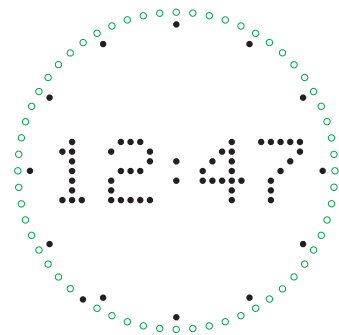

400A series clocks may be programmed to synchronise to EBU/SMPTE time code signals when the optional 404.E interface is fitted. Calendar clocks may be synchronised to one of two date formats.

401A, 420A and 490A clocks may be used as slave displays to a type 414 production timer correctly mirroring the production timer display.

Application	401, 420 & 490 Clocks		Calendar Clocks	
400A Clock program setting	Prog. 3, Opt. 15	Prog. 3, Opt. 16	Prog. 3, Opt 15	Prog. 3, Opt 16
482 Master Clock program settings	Prog. 17, Opt. '0' Prog. 18, Opt. '0'	Not applicable 414 Timer only	Prog. 17, Opt. '1' Prog. 18, Opt. '0'	Prog. 17, Opt. '1' Prog. 18, Opt. '1'

Bits	Data Bit Content				
0 - 3	Frame No. units	Frame No. units	Frame No. units	Frame No. units	
4 - 7	Unused bits	Unused bits	Unused bits	Status bits	
8 - 9	Frame No. tens	Frame No. tens	Frame No. tens	Frame No. tens	
10 - 11	Unused bits	Unused bits	Unused bits	Unused bits	
12 - 15			Days Units	Unused bits	
16 - 19	Seconds units	Seconds units	Seconds units	Seconds units	
20 - 23	Unused bits	Unused bits	Months units	Years units	
24 - 26	Seconds tens	Seconds tens	Seconds tens	Seconds tens	
27	Unused bits	Unused bits	Unused bit	Unused bit	
28 - 29			Days tens	Years tens	
30			Months tens		
31			Unused bit		
32 - 35	Minutes units	Minutes units	Minutes units	Minutes units	
36 - 39	Unused bits	Unused bits	Unused bits	Months units	
40 - 42	Minutes tens	Minutes tens	Minutes tens	Minutes tens	
43	Unused bits	Unused bits	Unused bit	Unused bit	
44 - 45			Years units	Months tens	
46 - 47			Unused bits	Unused bits	
48 - 51	Hours units	Hours units	Hours units	Hours units	
52 - 55	Unused bits	Unused bits	Unused bits	Days units	
56 - 57	Hours tens	Hours tens	Hours tens	Hours tens	
58 - 59	Unused bits	414 Control bits	Unused bits	Unused bits	
60 - 62		Unused bits		Years tens	Days tens
63				Unused bits	
64 - 79	Sync word	Sync word	Sync word	Sync word	

Serial ASCII Data Formats

400A Series clocks and calendar clocks, when fitted with a 404.2 (RS232) or 404.4 (RS485) optional internal interface module, are capable of synchronisation to one of three serial ASCII data message formats and will transmit messages in seven formats. The clock may be programmed to receive or transmit messages at 1200, 2400, 4800 or 9600 baud - *program function 10* -, seven or eight data bits - *program function 11* - and odd or even parity - *program function 12*.

When programmed to transmit serial messages - *by selecting options 1 to 7 of program function 9* - the clock will transmit a new message at every second edge. If the clock is programmed to transmit in one of the two 'on-demand' modes - *program function 7, selections 4 or 5* - the message will only be transmitted following the receipt of an ASCII 'T' or 't' - *program function 7, selection 4* - or the closure of an external voltage free switch contact - *program function 7, selection 5*.

Output Format 1 (*Input synchronisation - program function 3, selection 18*)

STX Su St Mu Mt Hu Ht Du Dt Mtu Mtt Yu Yt Stt ETX

Output Format 2 (*Input synchronisation - program function 3, selection 19*)

T Yt Yu : Mtt Mtu : Dt Du : 0 W : Ht Hu : Mt Mh : St Su CR LF

Output Format 3

T Yt Yu : Mtt Mtu : Dt Du : 0 W : Ht Hu : Mt Mh : St Su ` ` St CR LF

Output Format 4

T Yt Yu : Mtt Mtu : Dt Du : 0 W : Ht Hu : Mt Mh : St Su . Sht Shu CR LF

Output Format 5

T Yt Yu : Mtt Mtu : Dt Du : 0 W : Ht Hu : Mt Mh : St Su . Sht Shu ` ` St CR LF

Output Format 6 (*Input synchronisation - program function 3, selection 20*)

*** Ht Hu Mt Mu St Su CR LF**

Output Format 7

*** Ht Hu Mt Mu St Su Sht Shu CR LF**

't' = tens, 'u' = units value

Byte	Description	ASCII value	Byte	Description	ASCII value
STX	start transmission	02H	Sh	¹ / ₁₀₀ seconds	30 - 39H
ETX	end transmission	03H	S	seconds	30 - 39H
Stt	status - <i>see table</i>		M	minutes	30 - 39H
T	start transmission	54H	H	hours	30 - 39H
CR	carriage return	0DH	W	day-of-week	31 - 37H
LF	line feed	0AH	D	day-of-month	30 - 39H
:	colon	3AH	Mt	month	30 - 39H
.	point	2EH	Y	year	30 - 39H
` `	space	20H	0	zero	30H
*	start character	2AH			

Status Byte - ASCII value 30H - 3FH

Bit 0	0 = MSF	1 = DCF
Bit 1	0 = Winter time	1 = Summer time
Bit 2	0 = not synchronised	1 = synchronised
Bit 3	0 = no early warning bit	1 = early warning bit

The 402A Stopwatch Control unit enables a 401A, 420A or 490A series clock to be used both as a multifunction stopwatch and a time-of-day clock with the display freely switchable between time-of-day and stopwatch time. The time-of-day count may be synchronised to a wide variety of external time codes, impulses and time signals.

Four switches control the stopwatch count, display selection and function programming of the control unit. The operation of these switches is illustrated on the following pages.

The stopwatch function can be programmed to count:

- Up from zero - *program function SA, selection 1.*
- Down from a pre-programmed start-time to stop at zero - *program function SA, selection 2.*
- To count down and then up through zero - *program function SA, selection 3.* In this mode a minus sign will appear in the left hand character position when the count is minus and the most significant digit is zero.
- To continuously count down to zero with automatic re-start from a pre-programmed start time - *program function SA, selection 4.*

The stopwatch can be programmed to operate:

- In a simple start-stop mode - *program function SB, selection 1.*
- With one of four programmed split actions to enable the time intervals between sequential events to be timed incrementally or accumulatively. Please refer to pages 14 and 17 for further information. - *program function SB, selections 2 to 5.*

The stopwatch display can be programmed to show:

- Minutes, seconds and one hundredth seconds (minutes and seconds for 420A series clocks) - *program function SC, selection 1.*
- Hours, minutes and seconds (hours and minutes for 420A series clocks) - *program function SC, selection 2.*
- Minutes, seconds and one hundredth seconds (minutes and seconds for 420A series clocks) unless the hours count is one or more in which case the display automatically switches to show hours, minutes and seconds (minutes and seconds for 420A series clocks) - *program function SC, selection 3.*

The countdown start time can be programmed in hours, minutes and seconds (hours and minutes for 420A clocks). The programmed time is held in non-volatile EEPROM and is automatically recalled whenever the stopwatch is in a countdown mode and the 'RESET' switch is pressed or automatically when count option - 4 - is selected.

An optional internal interface module (404.R) provides a normally open voltage-free relay contact pair, rated at 24v 1A dc and programmable from one to three seconds contact closure duration in steps of 0.1 seconds, which starts when the countdown reaches zero - *program function SD, selections 0 (no contact closure) to 30 (3 seconds closure).*

The 402A Stopwatch Control unit can also be used to remotely set the clock to time and date.

The 402A controller unit is connected to the 401A, 420A or 490A clock by means of the three metre long three core cable provided. The interconnecting cable may be extended to ten metres length using a screened cable. Please refer to page 24 and 28 for details of the connections to the clock.

402A Stopwatch Controller -2

Prog. No.	Function	Selection Options	Comments
SA	Select count direction	1 = Up from zero	Reset switch sets count to zero.
		2 = Down from a pre-programmed start-time to stop at zero	Reset switch sets count to pre-programmed countdown start time.
		3 = Down from a pre-programmed start-time and then up through zero.	Minus sign displayed during countdown when most significant digit = 0.
		4 = Continuously count down to zero with automatic restart from a pre-programmed start time	
SB	Select START-HOLD-STOP switch action	1 = Single start - stop -start -stop count action.	Refer to page 17 for illustrations of count actions.
		2 = First action starts count, subsequent actions update display to new incremental split time.	
		3 = First action starts count, subsequent actions alternately freeze the display to show incremental split times and rejoin the running time.	
		4 = First action starts count, subsequent actions update display to new accumulative split time.	
		5 = First action starts count, subsequent actions alternately freeze the display to show accumulative split times and rejoin the running time.	
SC	Select display resolution	1 = Minutes seconds and $\frac{1}{100}$ seconds (minutes and seconds for 420A series)	
		2 = Hours, minutes and seconds (hours and minutes for 420A series)	
		3 = Minutes seconds and $\frac{1}{100}$ seconds (minutes and seconds for 420A series) unless the hours count is one or more when the display will show hours, minutes and seconds. (hours and minutes for 420A series)	
SD	Set period of relay contact closure at end of count-down	0 = No relay contact closure	Requires 404.R relay output option
		1 = 0.1 seconds contact closure	
		~	
		30 = 3.0 seconds contact closure	

Switch Control Unit Details

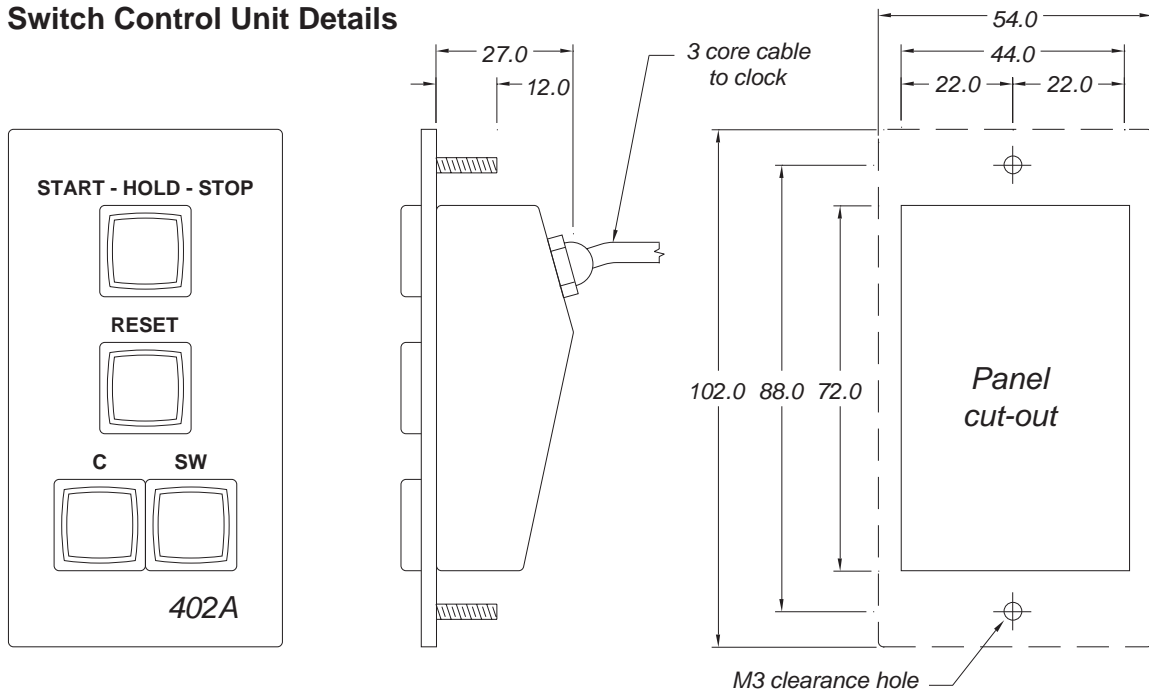

Control switch functions in normal operating mode

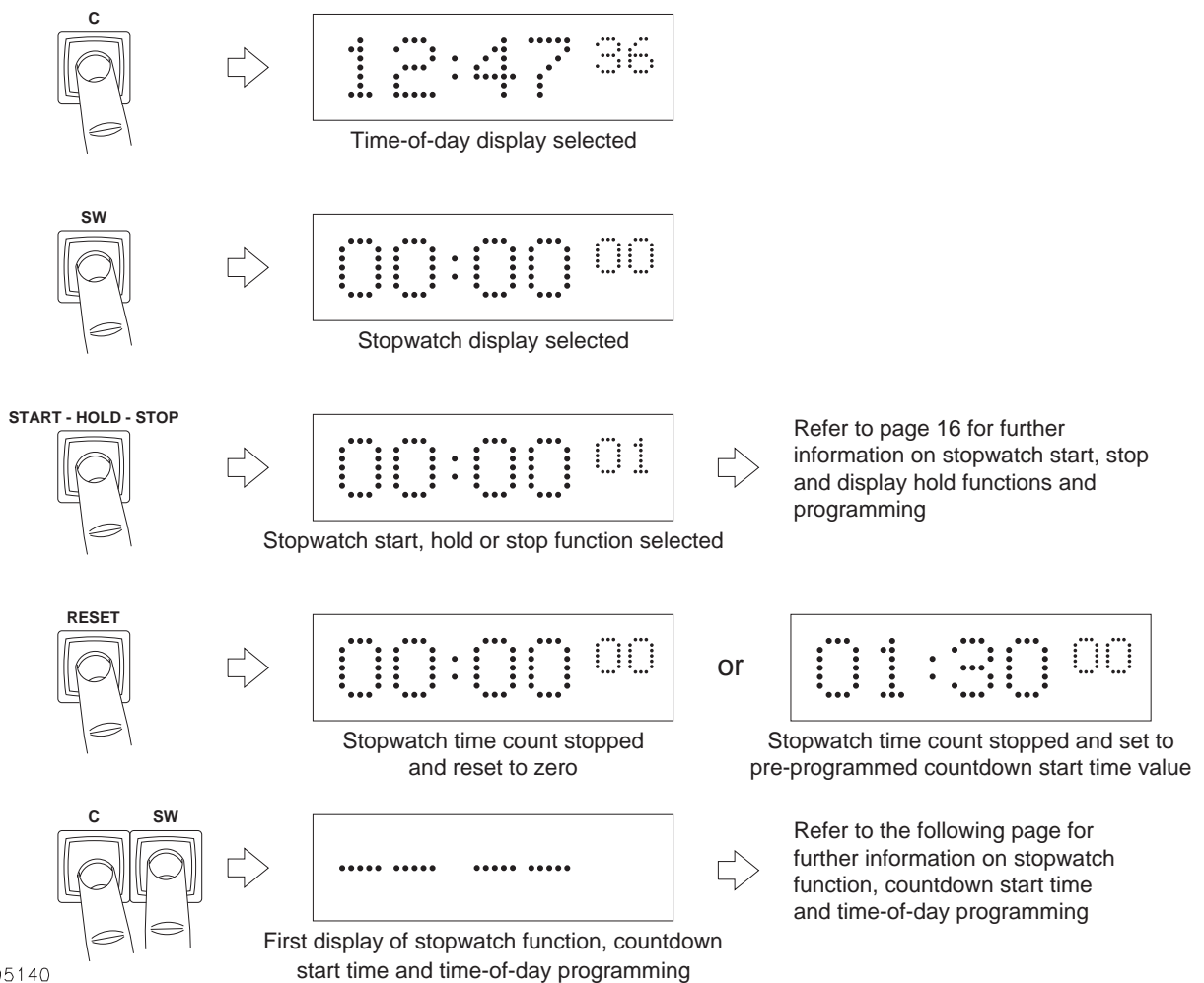

Control switch functions in programming and time-setting mode

Enter Programming Mode

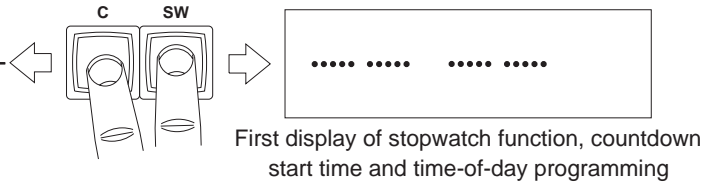

Set clock to time-of-day

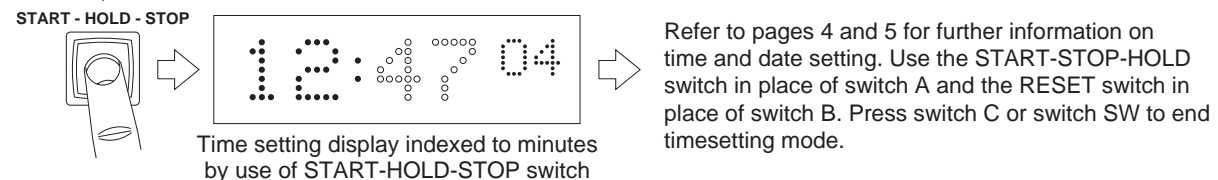
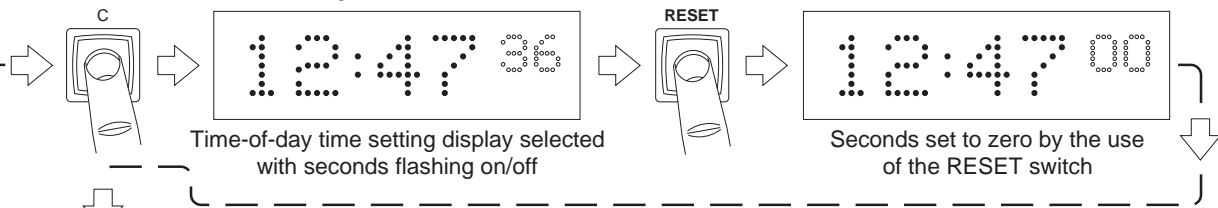

Program count-down start time

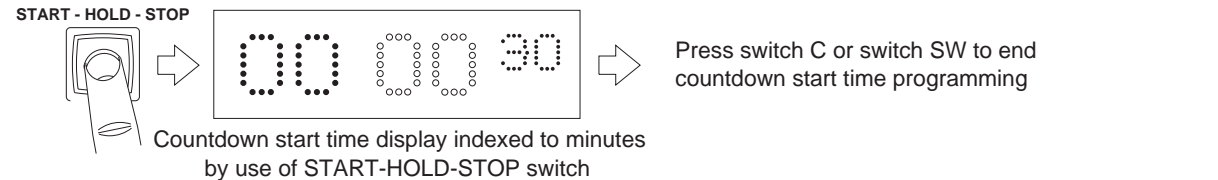
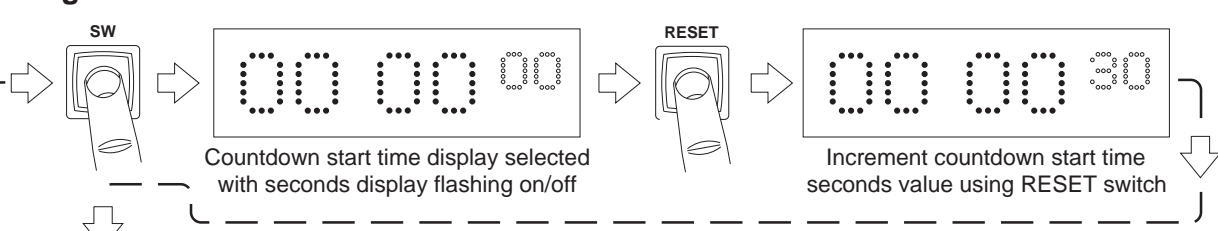

Program stopwatch count, display hold, display resolution and alarm time modes

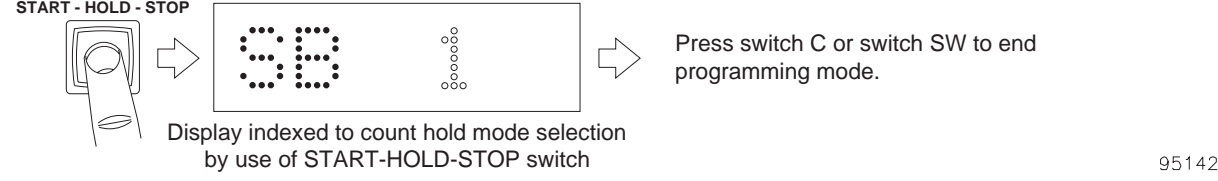
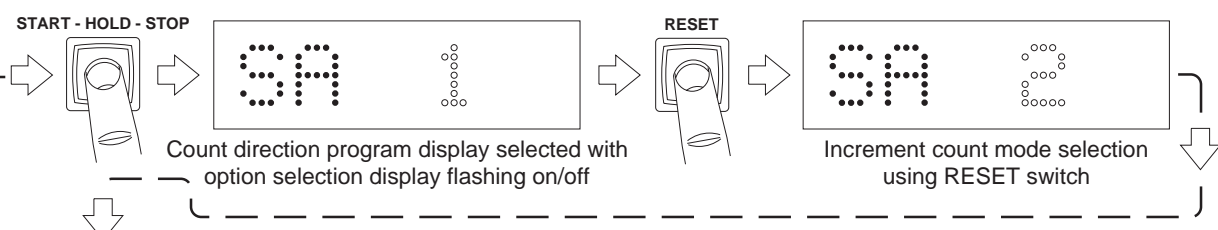

Stopwatch Count/Hold function options

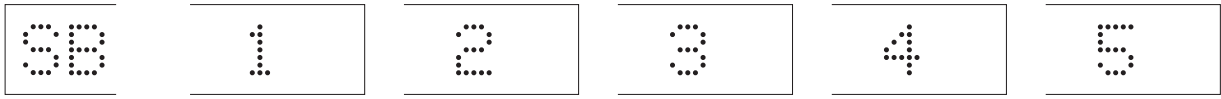

Count start/stop and display hold function selection

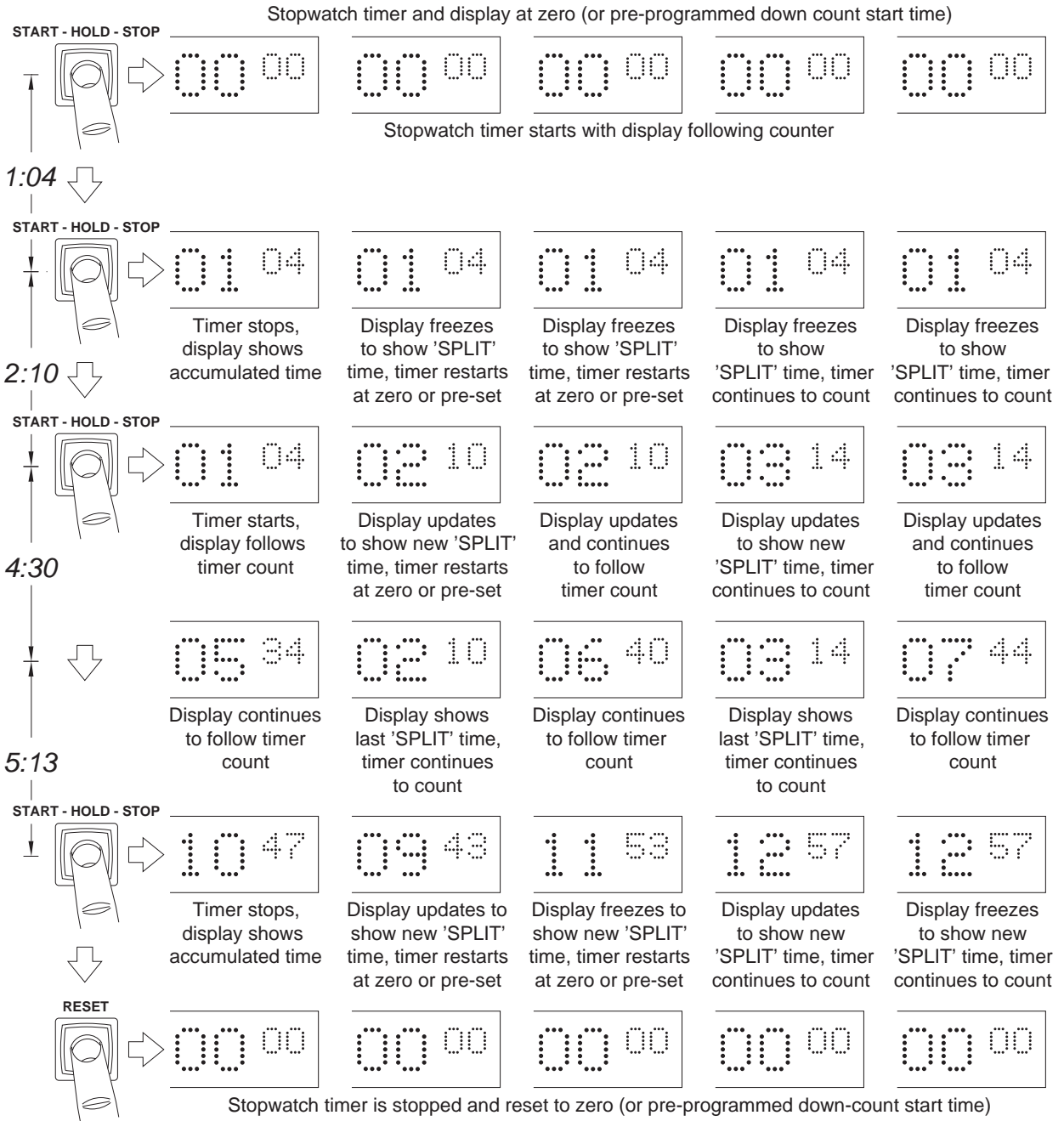

Switch Control Unit Details

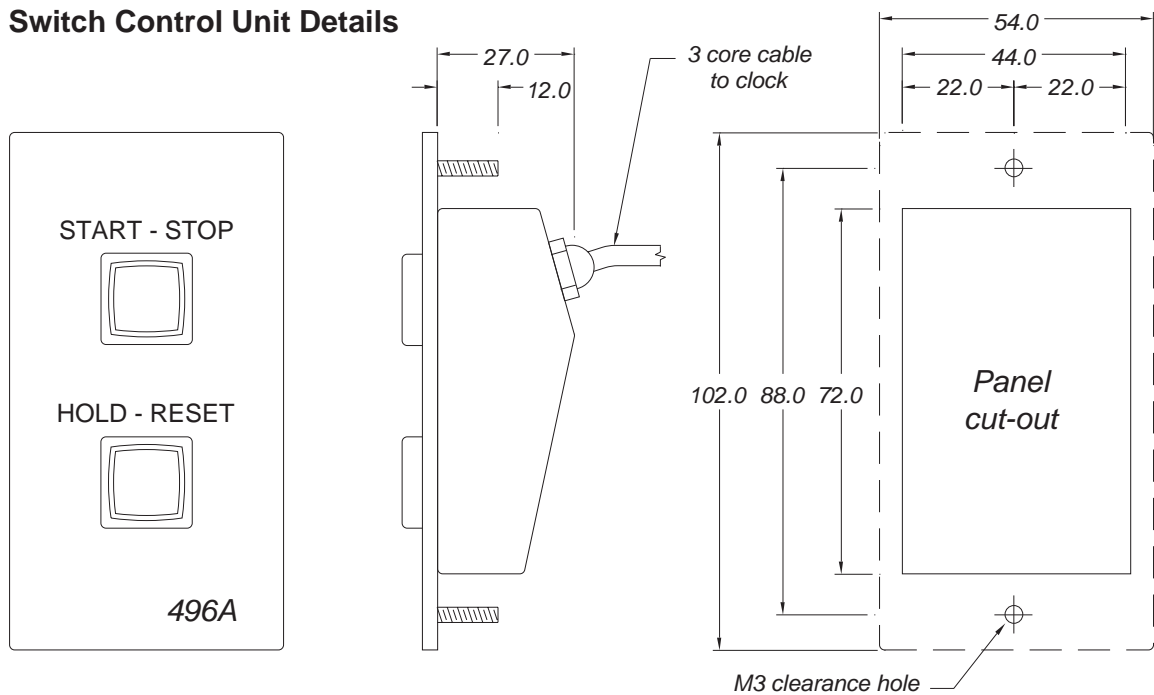

95145

The 496A Stopwatch Controller unit enables a 401A, 420A or 490A series clock to be used as a stopwatch. The clock may be programmed to display either :

- Hours, minutes and seconds (hours and minutes for 420A series clocks) - *program function 7, selection 1.*
- Minutes, seconds and $\frac{1}{100}$ th seconds (minutes and seconds for 420A series clocks) - *program function 7, selection 2.*

Two switches control the stopwatch count, display hold and reset operations. The different methods of operation of these switches are illustrated on the following page.

When a minutes, seconds and $\frac{1}{100}$ th second display is selected and the display is following the running time the $\frac{1}{100}$ th second character is blanked as it is impossible to read. When the display is held or stopped the $\frac{1}{100}$ th second character appears.

The 496A Stopwatch controller is connected to the 401A, 420A or 490A clock by means of the three metre long, four core cable provided. The interconnecting cable may be extended to ten metres length using a screen cable. Please refer to pages 24 and 28 for details of connections to the clock.

Stopwatch Count/Hold function options

Using START - STOP - RESET action

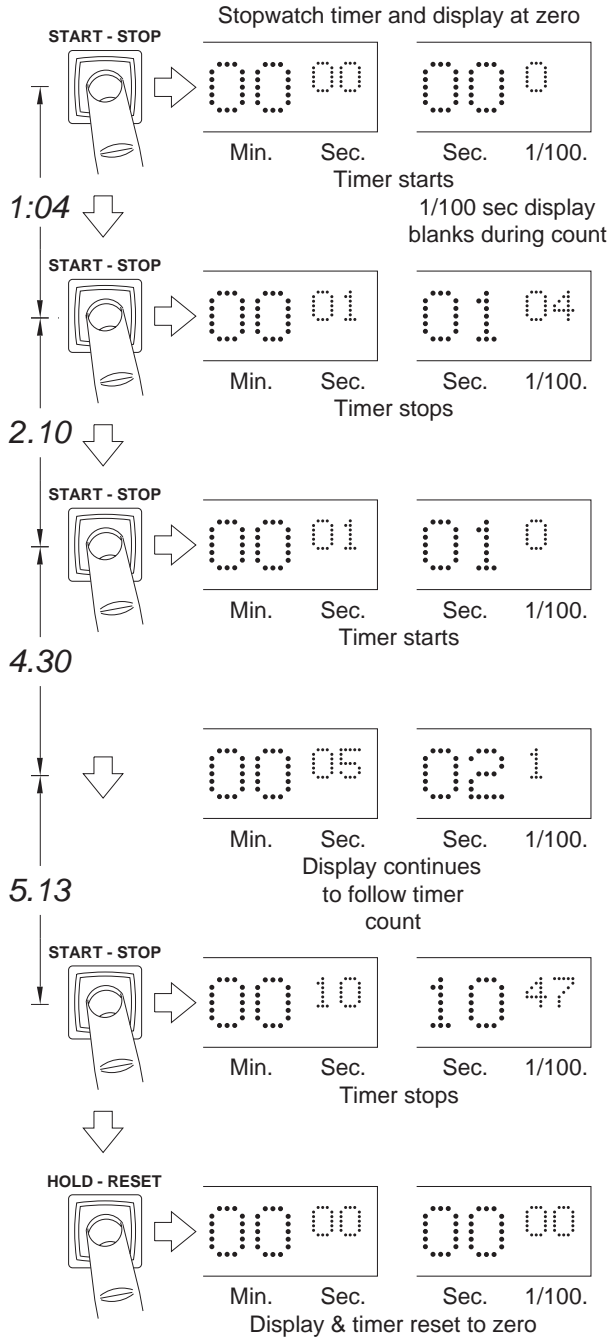
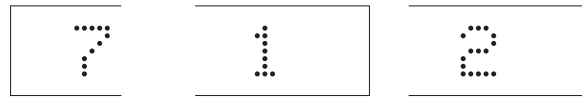

Note: The count must be stopped to enable reset to zero to be actioned.

Using START - HOLD - STOP action

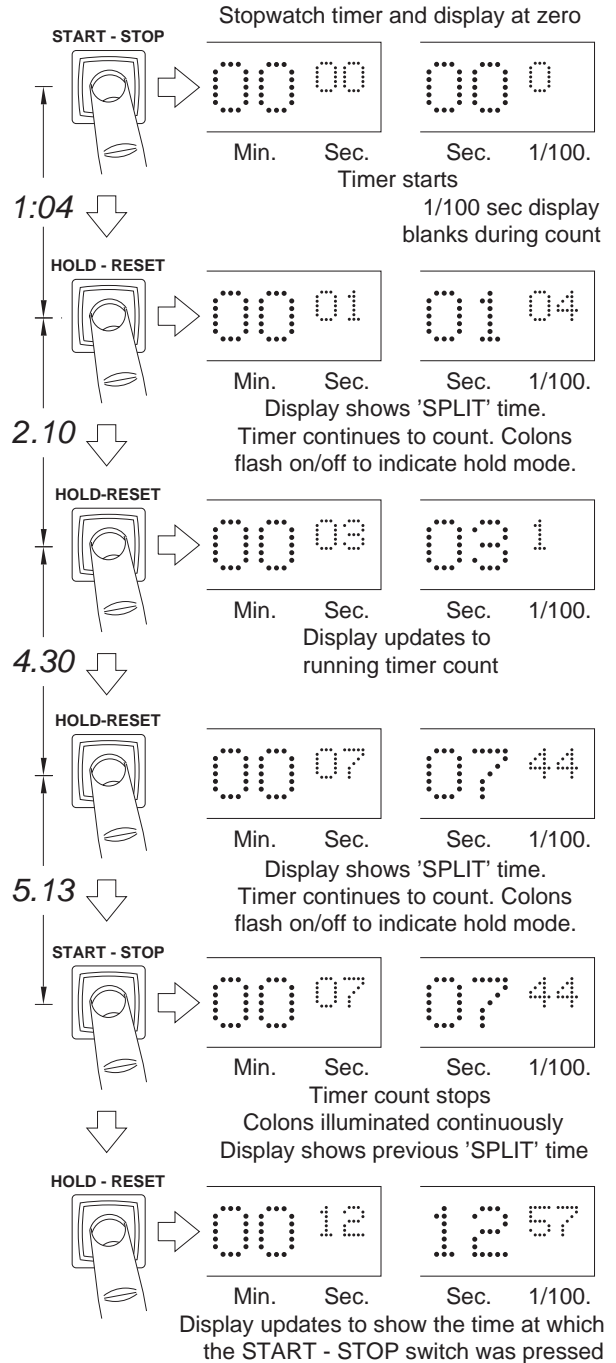

A further HOLD-RESET action will reset the timer count and display to zero.

Internal Interface Installation

The 400A series of clocks and calendar clocks may be programmed to synchronise to and to output a wide variety of signals. In a number of applications, as detailed throughout this manual, an optional internal interface module must be added in order to convert the external signals into the logic levels required by the 400A series clock or to generate the appropriate output signal levels.

The required interface module will normally, if specified at time of order, be factory installed during the testing procedure prior to dispatch. If it is necessary to subsequently install an interface module in a 400A series clock the following steps must be taken.

- **Ensure that any power supply to the clock is completely disconnected.**
- Place the clock on a conductive, grounded, work-surface ensuring that the case body is protected to avoid damage to the finish of the case and the front display filter.
- Unscrew the cross-head self-tapping screws which hold the rear panel to the clock case body. A 'Pozidrive' type screwdriver should be used and the screws saved for re-assembly.
- Locate and remove the battery connection jumper - *J4* - which is located above the end of the right-hand battery. To avoid loss retain the jumper on one pin of the *J4* header.
- By reference to the drawing below, locate the ten pin vertical header - *J5* - and remove the standard jumper connecting pins 2 and 3.
- The optional interface module must be installed with the ten way female socket mating with header - *J5*. The body of the female socket must be towards the square processor chip and on the side of the interface module away from the transformer and batteries. The side of the module carrying surface mounted components must be towards the batteries and transformer.
- Ensure that the module socket is correctly aligned with the - *J5* - header pins.
- Ensure that the flat, 20 way, interconnecting cable assembly between the display printed circuit board and the power/logic printed circuit board is correctly in place with the cable mounted socket securely seated on the shrouded board mounted plug - *J6*.
- Replace the *J4* jumper to re-connect the battery.
- Carefully replace the back cover of the clock ensuring that no strain is placed on the interconnecting cables. All of the original retaining screws must be replaced to ensure electrical and mechanical safety and EMC screening. If any screws have been misplaced they may be replaced with No. 4 x 3/8" self tapping countersunk screws.

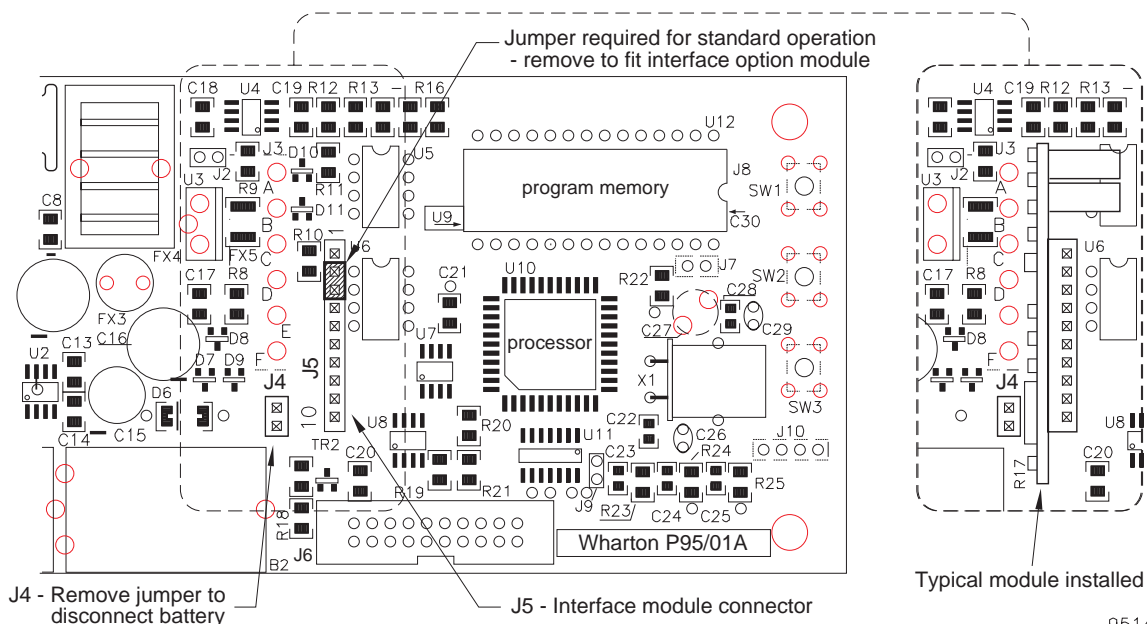

95147
Issue 2.2

	Internal Interface Module required	Program 3 Selection Option	402A Stopwatch Controller	402A with switch closure at 00:00.0	496A Stopwatch Controller	Alternate Time & Temperature Display	Serial Ascii Output every second	Serial Ascii Output on RS232/485 trigger	Serial Ascii Output on Switch Closure	400A Master Output to Control up to 10 slave clocks
Synchronisation Mode										
Stand-alone	None	1	✓	✓	✓	✓	✓	✓	✓	✓
Impulse	None	2 -7	✓	✗	✗	✓	✗	✗	✗	✗
W482 Time Code	None	8	✓	✗	✗	✓	✗	✗	✗	✗
MSF & DCF Radio Time Code	None	9 - 12	✓	✓	✗	✓	✓	✓	✓	✓
IRIG-B & afnor Nf S 87-500 Code	404.I	13 -14	✗	✗	✗	✗	✗	✗	✗	✗
EBU/SMPTE Time Code	404.E	15 - 16	✗	✗	✗	✗	✗	✗	✗	✗
400A Local Slave Mode	None	17	✓	✗	✗	✓	✗	✗	✗	✗
RS232 Serial Ascii	404.2	18 - 20	✗	✗	✗	✗	✗	✗	✗	✗
RS485 Serial Ascii	404.4	18 - 20	✗	✗	✗	✗	✗	✗	✗	✗
H310® Time Code	None	21	✓	✗	✗	✓	✗	✗	✗	✗
Mobaline® Time Code	None	22	✓	✗	✗	✓	✗	✗	✗	✗
GPS code from 488GPS System	None	23	✓	✗	✗	✓	✗	✗	✗	✗

System configurations indicated by ✓ are available. Configurations indicated by ✗ are not available. Serial RS232 or RS485 outputs require an internal 404.2 (RS232) or 484.4(RS485) module. 400A Master Clock **output** operation requires an internal **404.M** module.

Temperature Display

Two temperature display modes are available. The temperature may be displayed continuously or alternately exchanged with the hours and minutes time display. When the alternate time/temperature display mode is selected the period between display changes may be adjusted by the user.

An external type 406 Temperature Sensor module is required to allow temperatures in the range -17°C to +50°C to be displayed. The 406 module is normally supplied with a three core, 5m connecting cable which may be user extended up to a maximum of 100m. The connection of the module to the 400A series clock is illustrated on page 28 of this manual.

The 406 module is housed in a two part, clip together, ventilated case measuring 70mm x 70mm x 25mm deep. The module may be mounted on a suitable vertical surface, either by the use of two strips of double sided tape or by mechanical fixing via two screws through the marked positions in the detachable base plate of the unit. The module must be mounted in a position where it is not subject to direct rain or other water spray.

Please refer to pages 4 - 9 of this manual for programming information.

Important note: The clock should be programmed to the required temperature display function with the temperature sensor disconnected. The temperature sensor must be connected to the clock after the required display mode has been programmed.

To program a 400A series clock to display temperature information *program function 7* should be set to *selection 'C'* to display alternating time and temperature or *selection '0'* to display the temperature only.

The temperature sensor is factory calibrated to $\pm 1^\circ\text{C}$. However any temperature display system is subject to errors caused by installation location related environmental conditions. The correct temperature should be established by reference to an accurate shielded thermometer. *Program function 8* allows the displayed temperature to be corrected to compensate for errors, when *program function 8* is selected the display flashes on/off showing the adjusted temperature. The displayed value may be adjusted, up or down by up to 5 degrees, to the required corrected value by use of the 'B' setting switch. The correction factor is permanently stored in non-volatile memory.

Program function 13 allows the 'hold time' between display changes to be set in the range 1 to 15 seconds. Note that the alternating cycle is always returned to show time information at the start of each new minute.

Local Master Clock Mode

The local master clock mode enables any 400A series clock, when fitted with an internal 404.M interface module, to control up to ten 400A clocks operating as slaves with a maximum cable length of 200m.

A 400A clock will only operate as a 'local master' clock if, in addition to having a 404.M module installed, it is maintaining its timekeeping from the internal high stability crystal (stand-alone synchronisation mode) or it is synchronised to MSF or DCF radio time code via a 484 series receiver.

Any 400A clock will operate as a 'local slave' as the interface circuit is present as standard.

The master clock should be programmed, by reference to pages 4 - 9 of this manual, as follows:

- *Program function 3 - Synchronisation mode - selection 1, 9, 10, 11 or 12 as appropriate*
- *Program function 7 - External Controller mode - selection 0*
- *Program function 9 - Serial Output mode - selection 0*

Each slave clock should be programmed as follows:

- *Program 3 - Synchronisation mode - selection 17*

The slave clocks should be connected in parallel to the master clock, by reference to the connection diagrams shown on page 28 of this manual, using a single twisted pair cable.

The interconnecting cable may be unscreened in the majority of installations but should be screened in the presence of high levels (1V/m) of radio frequency emissions or when the interconnecting cable runs are adjacent to machinery or equipment likely to produce significant levels of electrical noise.

If screened cable is used the screen should be grounded at the 400A local master clock end only.

The 400A series clocks will, when connected to an appropriate 484 series radio receiver and programmed for radio time code synchronisation, automatically synchronise to the radio time code information transmitted from radio station DCF located at Mainflingen near Frankfurt or from MSF at Rugby. The clock may display BST - *program function 3, selection 9* - (MSF synchronised), CET - *program function 3, selection 11* - (DCF synchronised) or UTC (GMT) from either MSF - *selection 10* - or DCF - *selection 12*. The DCF signal is transmitted at 77.5KHz and is derived from an atomic clock at the Physics Institute of Brunswick. The MSF signal is transmitted at 60KHz and is referenced to the Caesium Beam Oscillator at the National Physical Laboratory.

The type 484.02 (MSF) and 484.03 (DCF) time signal receivers are housed in a compact weather-proof case and are connected to the clock or master clock by a single cable pair. In many locations the receiver will operate within the building. In difficult reception areas, where an external mounting point is required, the receiver unit may be located up to 200 metres from the clock.

The type 484.06 (MSF) and 484.07 (DCF) time signal receivers are low cost units for internal use only.

Installation

The 484 series radio time code receiver should be mounted:

- At *least* 2 metres from the 400A series clock.
- At the greatest practical distance from:
Other electrical equipment including computers, fluorescent lights and signs, metal girders and reinforced concrete walls. Any other sources of electrical noise.
- Preferably on the outside of the building (484.02 and 484.03 only) as high as possible. The case is weatherproof to IP65 but it is preferable to provide some protection from direct rain.
- With the cable entry on the lower face of the case (484.02 and 484.03).

The 484 series receiver may be connected to the 400A series clock directly by means of the cable provided or, at a greater distance, by means of a suitable extension cable.

At distances of up to 10 metres unshielded two core cable may be used. At greater distances, or in areas of high electrical noise, a two core shielded cable must be used with the shield grounded at one end only. The maximum recommended distance between the receiver and master clock is 200 metres.

Alignment

The 484.02 and 484.03 radio receivers have dual ferrite antenna which normally permit location regardless of orientation to the transmitter. The receiver is mounted by means of the four fixing holes in the rear surface which are accessed after removing the front cover. The four mounting holes are located outside of the central sealed compartment. The 484.06 and 484.07 receivers have a single antenna element and are supplied with an adjustable mounting bracket to enable orientation with the longest face of the receiver at 90° to the direction of the transmitter.

The front cover of the 484.02 and 484.03 receivers may be removed to enable an indicator LED to be viewed. The indicator LED for the 484.06 and 484.07 receiver is located in the front face of the unit. The alignment of the receiver is correct when the LED flashes on/off once per second.

Signal Reception

Under normal circumstances the DCF signal provides reliable operation at distances of up to 1500km. MSF signals are normally usable up to 1000km. Greater operating ranges are possible at night. The received and decoded signal provides an operating accuracy of better than ± 20 ms and provides completely automatic seasonal time changes.

In best conditions the 400A series clock will take three minutes to synchronise with the transmitted time code from either DCF or MSF. When the 400A series clock is 'locked' to the transmitted signal, the colon between the hours and minutes characters is illuminated continuously. During periods of signal failure or signal corruption the clock will maintain timekeeping using its internal high stability quartz crystal oscillator and the colons will flash on/off every second.

It should be noted that MSF is off the air for maintenance purposes from 10:00 to 14:00 on the first Tuesday of each month and usually for up to two weeks during the summer months for annual maintenance. The MSF transmission status can be checked by telephoning 020 8943 6493.

Mounting Details - 400A.02 Series Panel Mounting Clocks

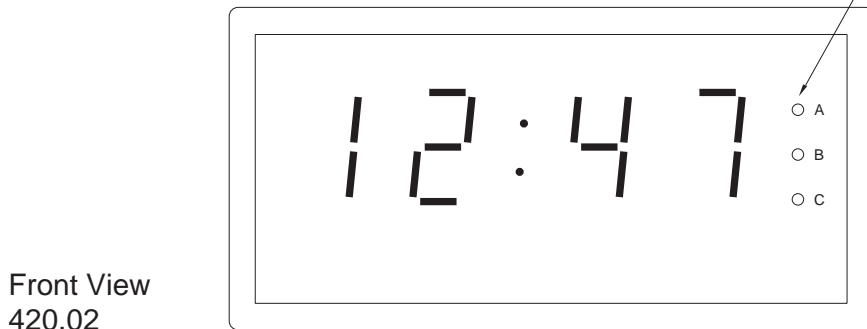
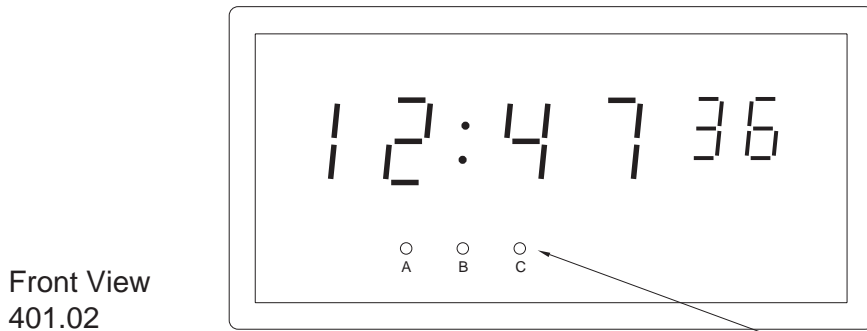
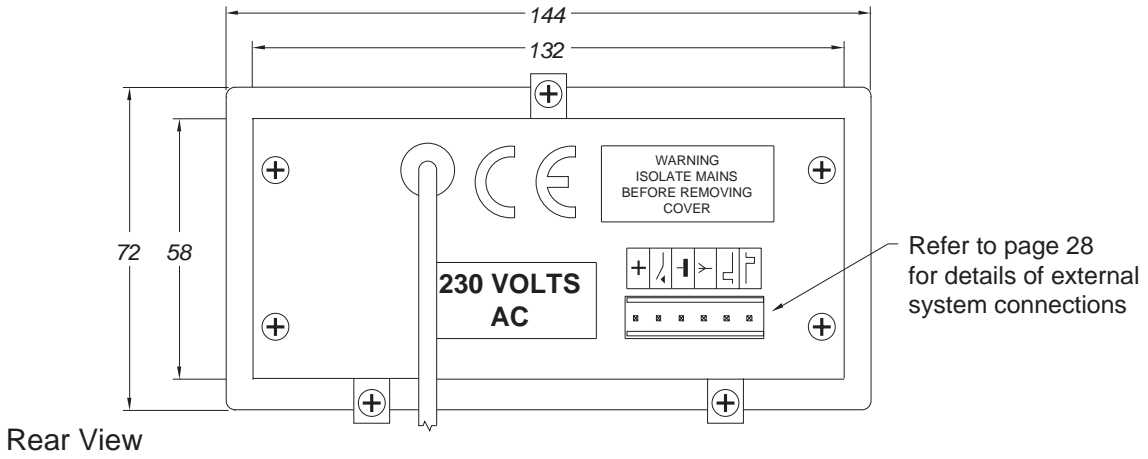
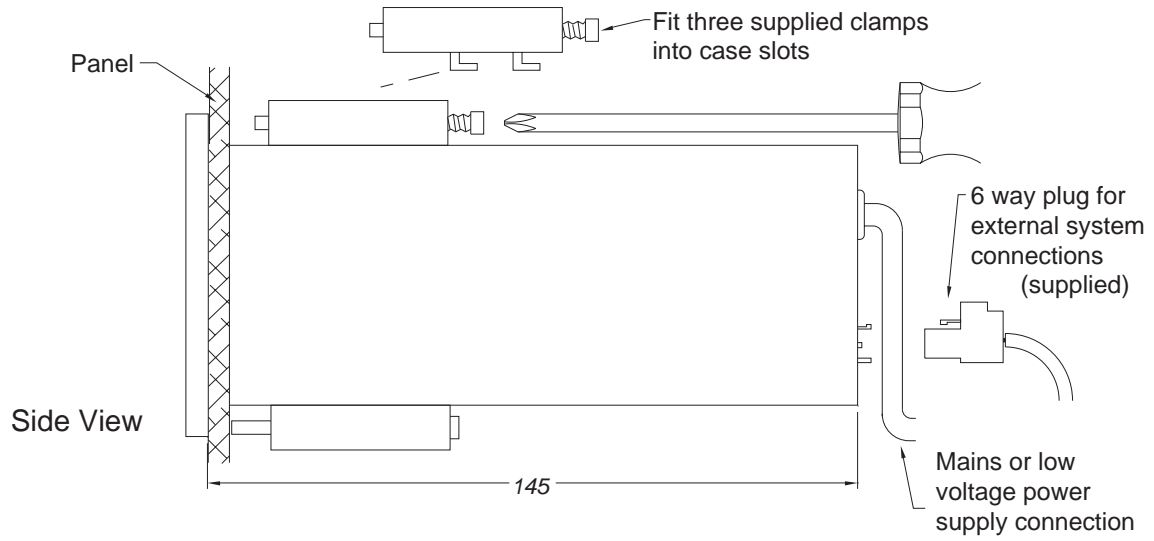

Time, Date & Program Setting Switches

Mounting Details - Ceiling Suspended Cases

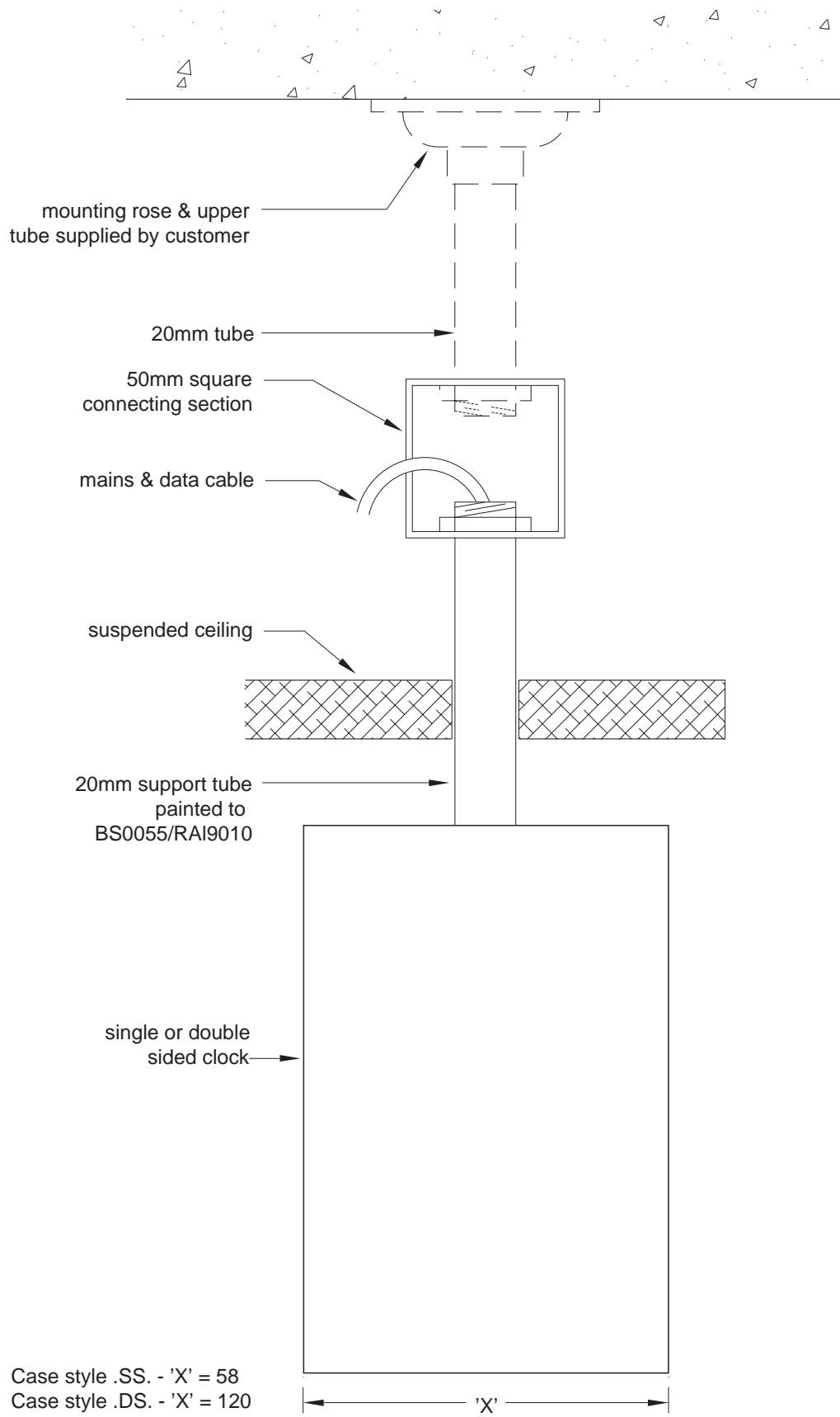

Mounting Details - Flush Mounting Cases

Flush Fitting Panel Case

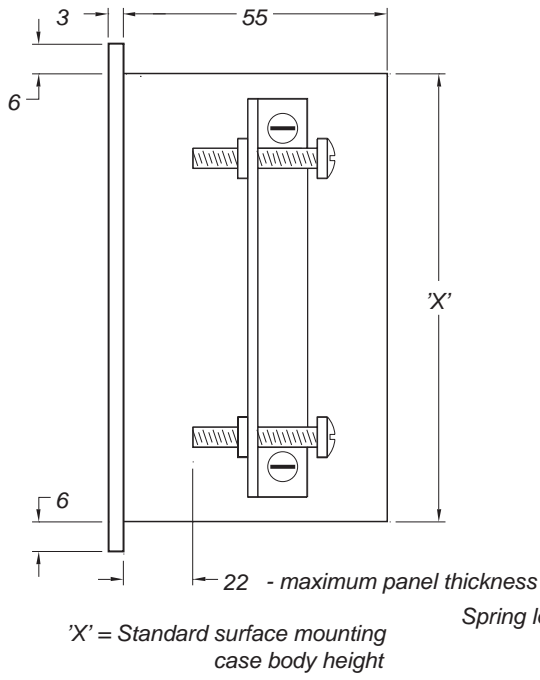

Flush Fitting Case with Mounting Box

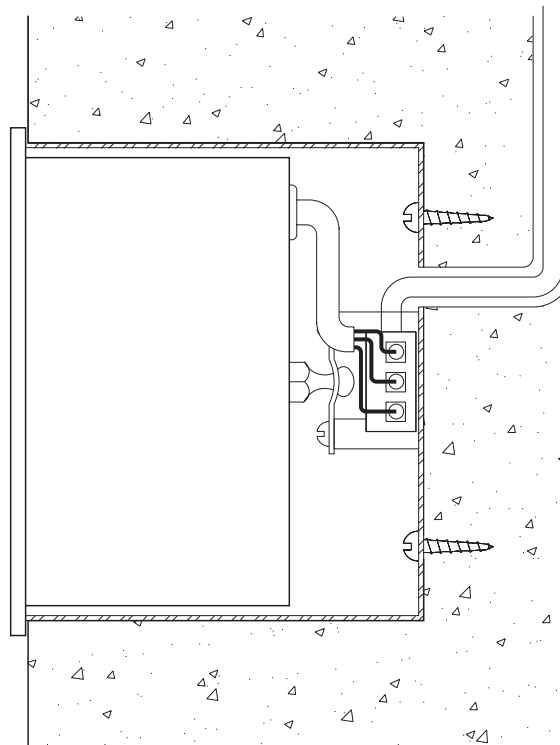
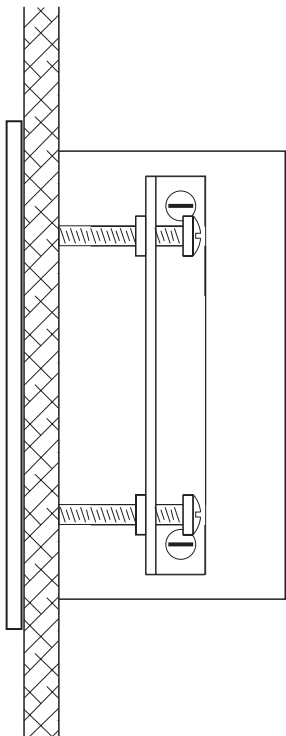
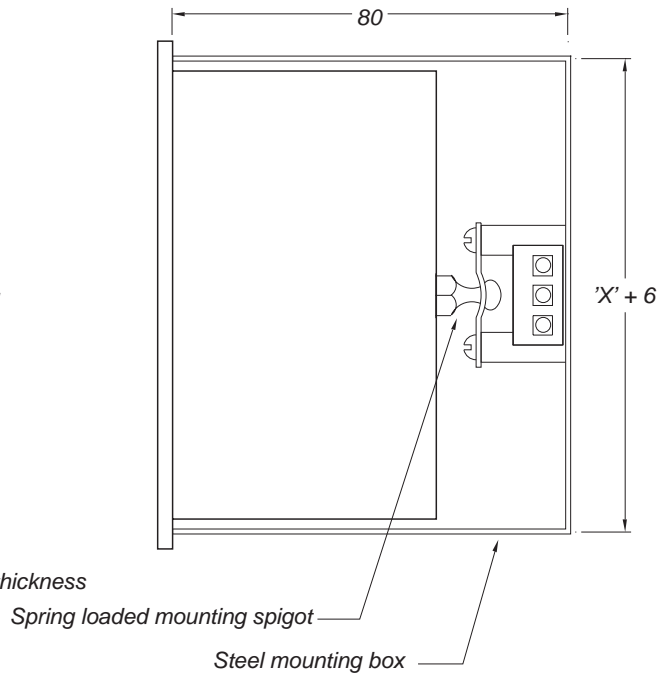

Mounting Details - Surface Mounting Cases

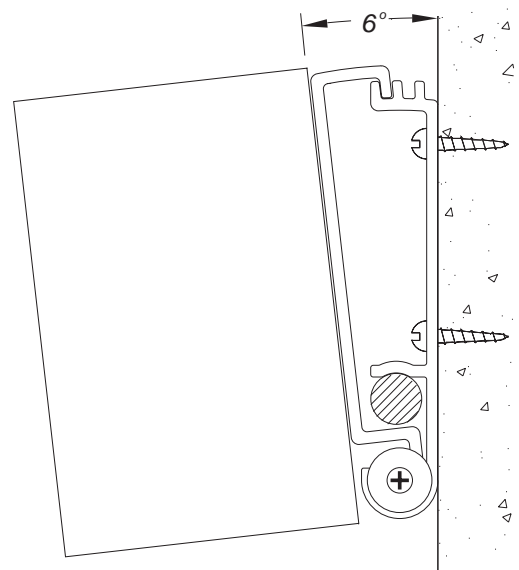
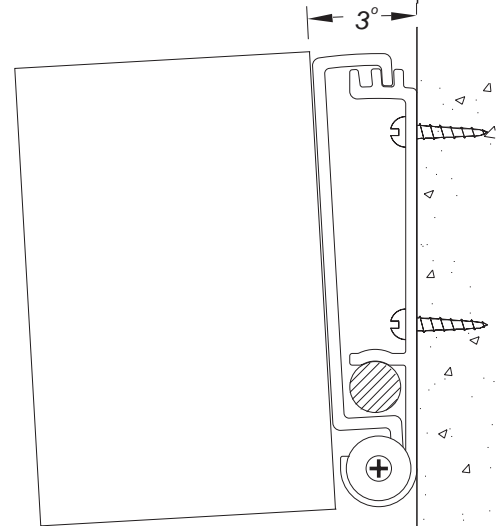
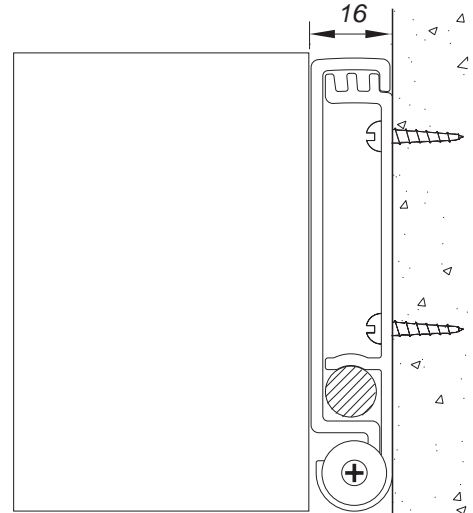
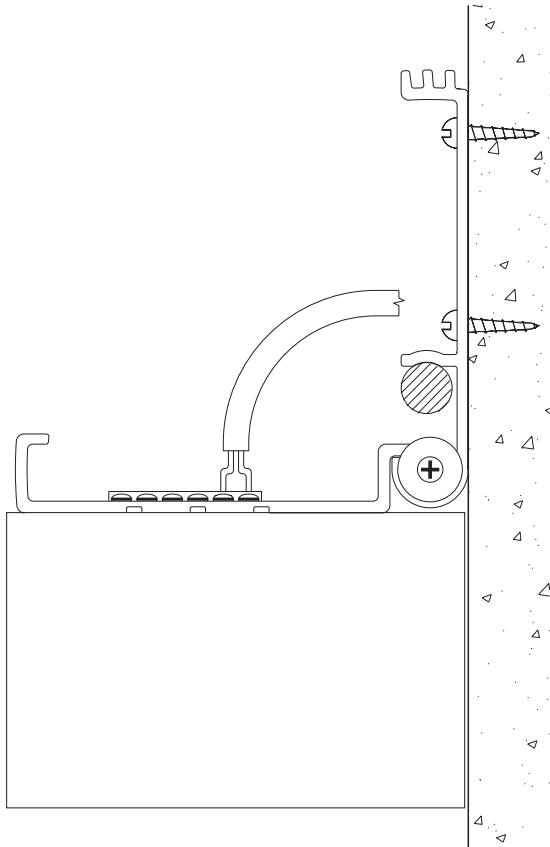

Model	Case Size L x H x D	Fixing Centres
401A.05	305 x 90 x 58	195
420A.05	240 x 90 x 58	130
420A.06	240 x 90 x 58	130
450A.05	550 x 90 x 58	440
451A.05	550 x 90 x 58	440
452A.05	480 x 180 x 58	370
453A.05	480 x 180 x 58	370
454A.05	300 x 300 x 58	190
460A.05	460 x 90 x 58	350
490A.05	300 x 300 x 58	190

External Interface Connections

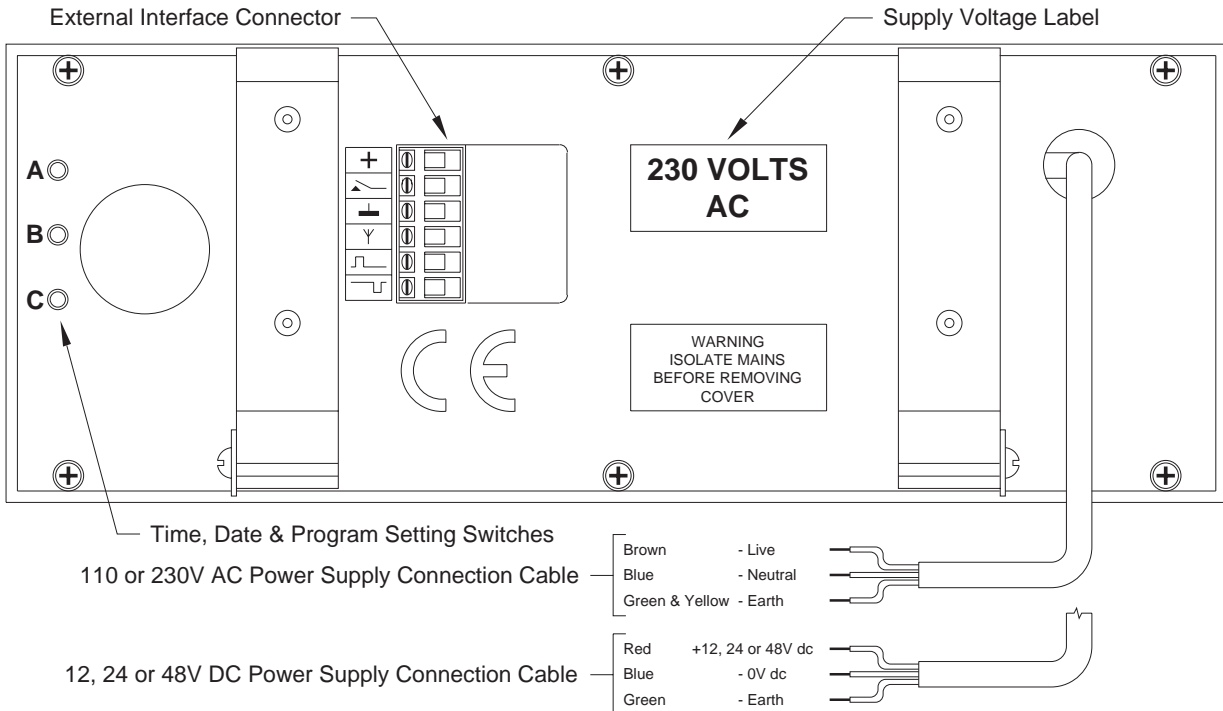

<p>484 Series DCF or MSF Radio Time Code Receiver</p>	<p>EBU/SMPTE Time Code</p> <p>Requires 404.E internal interface</p>
<p>496A Stopwatch Controller</p>	<p>RS232 Serial ASCII</p> <p>Requires 404.2 internal interface</p>
<p>402A Up/Down Stopwatch Controller 406 Temperature Sensor</p>	<p>RS485 Serial ASCII</p> <p>Requires 404.4 internal interface</p>
<p>Alternate Polarity 12-24v impulses* W482 Time Code* H310 Time Code* 'Local Slave' Mode* Uni-polar 12-24v impulses 'A' = common, 'B' = pulse ML time code</p> <p>* = Connector polarity is not critical</p>	<p>Local Master Operation</p> <p>Requires 404.M internal interface For control up to ten off 400 series 'Local Slave Clocks'</p>
<p>IRIG-B Time Code Afnor NF S 87-500 Time Code</p> <p>Requires 404.I internal interface</p>	<p>RS232 'switch trigger'</p>

Program Option Record Sheet

Program No.	Function	Date		

1	Display brightness			
2	Hour display mode			
3	Synchronisation mode			
4	Run mode			
5	Time zone			
6	GPS time offset			
7	External controller mode			
8	Temperature adjustment			
9	Serial output format			
10	Baud rate			
11	Bit length			
12	Parity			
13	Display Hold Time			
14	Seasonal time change-over mode			
15	Special display mode			
16	Number of languages			
17	First language selection			
18	Second language selection			
19	Third language selection			

SA	402 Stopwatch Controller count direction			
SB	402 Stopwatch Controller hold mode			
SC	402 Stopwatch Controller display mode			
SD	402 Stopwatch Controller alarm time			

Clock Type		Serial No.	
-------------------	--	-------------------	--



Wharton Electronics

Unit 15, Thame Park Business Centre
Wenman Road, Thame, Oxfordshire, England. OX9 3XA

Email: info@wharton.co.uk
WWW: <http://www.wharton.co.uk>
Telephone: +44 (0) 1844 260567
Fax: +44 (0) 1844 218855